

# BM series

## INSTRUCTION MANUAL

### Analytical Balance

BM-20

BM-22

BM-252

BM-200

BM-300

BM-500

© 2010 A&D Company Ltd. All rights reserved.

No part of this publication may be reproduced, transmitted, transcribed, or translated into any language in any form by any means without the written permission of A&D Company Ltd.

The contents of this manual and the specifications of the instrument covered by this manual are subject to change for improvement without notice.

Windows, Word and Excel are registered trademarks of the Microsoft Corporation.

# Contents

## Basic Operation

|      |  |    |
|------|--|----|
| 1.   | Introduction.....  | 3  |
| 1.1. | Features.....  | 4  |
| 1.2. | Compliance.....  | 5  |
| 2.   | Unpacking The Balance.....   | 6  |
| 3.   | Installing The Balance And Precautions.....                            | 8  |
| 3.1. | Installing The Balance.....  | 8  |
| 3.2. | Precautions Before Use (Environmental Condition And Preparations)..... | 10 |
| 3.3. | Cautions During Use (For Precision Weighing).....                      | 11 |
| 3.4. | Cautions After Use (Management Of The Balance).....                    | 12 |
| 3.5. | Cautions For Power Supply.....   | 12 |
| 4.   | Display Symbols And Key Operation.....                                 | 13 |
| 5.   | Weighing Units.....  | 14 |
| 5.1. | Units.....   | 14 |
| 5.2. | Storing Active Units.....  | 17 |
| 5.3. | Selecting Unit And Weighing Mode.....                                  | 18 |
| 6.   | Weighing.....  | 20 |
| 6.1. | Basic Operation (Gram Mode).....                                       | 20 |
| 6.2. | Smart Range For BM-22.....   | 21 |
| 6.3. | Counting Mode (PC).....  | 22 |
| 6.4. | Percent Mode (%).....  | 24 |
| 6.5. | Built-in DC Static Eliminator (Neutralization Device).....             | 25 |
| 6.6. | Monitoring Clock and Environmental Sensors.....                        | 27 |
| 6.7. | Repeatability Test.....  | 28 |

## Adapting To The Environment

|      |  |    |
|------|--|----|
| 7.   | Response Adjustment.....   | 29 |
| 7.1. | Automatic Response Adjustment.....                                     | 29 |
| 7.2. | Manual Response Adjustment.....  | 30 |
| 8.   | Calibration (To Adjust The Weighing Value).....                        | 31 |
| 8.1. | Calibration Group.....   | 31 |
| 8.2. | Automatic Self Calibration (For variation of ambient temperature)..... | 32 |
| 8.3. | One-Touch Calibration (For Common Use).....                            | 32 |
| 8.4. | Calibration Test Using the Internal Mass.....                          | 33 |
| 8.5. | Calibration Using An External Weight.....                              | 34 |
| 8.6. | Calibration Test Using An External Weight.....                         | 35 |
| 8.7. | Correcting The Internal Mass Value.....                                | 36 |
| 9.   | Function Switch And Initialization.....                                | 37 |
| 9.1. | Permit Or Inhibit.....   | 37 |
| 9.2. | Initializing The Balance.....  | 38 |

## Selecting Functions

|       |  |    |
|-------|--|----|
| 10.   | Function Table.....                                  | 39 |
| 10.1. | Setting The Function Table.....                      | 39 |
| 10.2. | Details Of The Function Table.....                   | 41 |
| 10.3. | Description Of The Class "Environment, Display"..... | 43 |

|                                    |  |    |
|------------------------------------|--|----|
| 10.4.                              | Description Of The Item "Data Output Mode" .....       | 45 |
| 10.5.                              | Description Of The Item "Data Format" .....            | 46 |
| 10.6.                              | Data Format Examples.....                              | 49 |
| 10.7.                              | Clock And Calendar Function.....                       | 51 |
| 11.                                | ID Number And GLP Report .....                         | 52 |
| 11.1.                              | Setting The ID Number.....                             | 52 |
| 11.2.                              | GLP Report.....  | 53 |
| 12.                                | Data Memory.....                                       | 58 |
| 12.1.                              | Notes On Using Data Memory .....                       | 58 |
| 12.2.                              | Data Memory For Weighing Data.....                     | 59 |
| 12.3.                              | Data Memory For Calibration And Calibration Test.....  | 62 |
| 13.                                | Underhook.....   | 63 |
| 14.                                | Density Measurement (Specific gravity) .....           | 64 |
| <b>Interface And Communication</b> |  |    |
| 15.                                | Standard Input And Output Interface.....               | 67 |
| 15.1.                              | RS-232C Interface.....                                 | 67 |
| 15.2.                              | Connection To Peripheral Equipment.....                | 68 |
| 15.3.                              | Commands .....   | 71 |
| <b>Maintenance</b>                 |  |    |
| 16.                                | Maintenance.....                                       | 76 |
| 16.1.                              | Treatment Of The Balance .....                         | 76 |
| 16.2.                              | Error Codes .....                                      | 76 |
| 16.3.                              | Other Display .....                                    | 78 |
| 16.4.                              | Checking The Balance Performance And Environment ..... | 79 |
| 16.5.                              | Asking For Repair.....                                 | 79 |
| 17.                                | Specifications .....                                   | 80 |
| 17.1.                              | External Dimensions.....                               | 81 |
| 17.2.                              | Options And Peripheral Equipment.....                  | 82 |
| 18.                                | Terms/Index.....                                       | 86 |
| 18.1.                              | Terms .....  | 86 |
| 18.2.                              | Index .....  | 87 |

# 1. Introduction

This manual describes how the BM series balances work and how to get the most out of them in terms of performance. Read this manual thoroughly before using the balance and keep it at hand for future reference.

## About This Manual

This manual consists of the following five parts:

- Basic operation ..... Describes precautions, the balance's construction and basic operation.
- Adapting to the environment..... Describes response (and stability) adjustment to adapt to the environment where there is vibration or drafts, the way to maintain weighing precision in a variation of ambient temperature, calibration and calibration test.
- Selecting functions ..... Describes functions of the balance.
- Interface and communication..... Describes the serial interface used for communicating with a computer that requests weighing data and controls the balance, and for use with a printer
- Maintenance ..... Describes maintenance, error codes, troubleshooting, specifications and options.

## 1.1. Features

- A built-in DC static eliminator can eliminate static electricity from the weighing sample before the measurement, reducing weighing error.
- Each electrode unit of the eliminator is designed to be removed, cleaned and replaced.
- Automatic self calibration, using the internal mass, adapting to changes to temperature changes.
- Response adjustment adapting to drafts and/or vibration automatically.
- Memory function to store weighing data and calibration data.  
When only weighing data is stored, a maximum of 200 data can be stored.  
Interval mode to store the weighing data periodically.
- Good laboratory practice (GLP) data can be output using the RS-232C serial interface.
- A built-in clock and calendar that can add the time and date to the output data.
- Underhook, for measuring density and weighing magnetic materials.
- Multiple weighing units with most of the common units used around the world.  
Gram, Milligram, Counting mode, Percent mode, Ounce (Avoir), Troy Ounce, Metric carat, Momme, Pennyweight, Grain (UK), Tael (preset in the factory), Tola (India), Messghal, Density mode
- **BM-22** is equipped with a smart range function to weigh with the precision range (a higher resolution) when zeroing a tare weight within the weighing capacity.
- The test tube holder is included in the accessories of **BM-20** and **BM-22**.
- Density mode for calculating the density of a solid.
- BM series balances are equipped with an RS-232C serial interface and a USB interface to communicate with a computer. When printing data using the RS-232C interface, by using the USB interface, the data can be transmitted to a computer at the same time. Communications between the BM series balance using the RS-232C interface and a Windows computer using the Windows communication tools software (WinCT) make building a system very easy.
- Connecting the USB interface of the balance, by cable to a Windows computer, allows transmission of the weighing data to Excel or Word.
- When multiple balances have the BM-08 Ethernet interface installed in place of the USB interface and connected to a LAN, data can be acquired from each of them using the WinCT-Plus software.
- The weighing data can be stored by connecting the accessory data logger (AD-1688) directly, when not using a computer.

## 1.2. Compliance

### 1.2.1. Compliance With FCC Rules

---

Please note that this equipment generates, uses and can radiate radio frequency energy. This equipment has been tested and has been found to comply with the limits of a Class A computing device pursuant to Subpart J of Part 15 of FCC rules. These rules are designed to provide reasonable protection against interference when equipment is operated in a commercial environment. If this unit is operated in a residential area, it may cause some interference and under these circumstances the user would be required to take, at his own expense, whatever measures are necessary to eliminate the interference.

(FCC = Federal Communications Commission in the U.S.A.)

### 1.2.2. Compliance With EMC Directives

---

**CE** This device features radio interference suppression and safety regulation in compliance with the following Council Directives

Council directive 89/336/EEC      EN61326      EMC directive









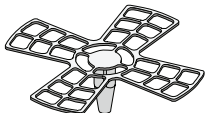
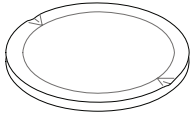
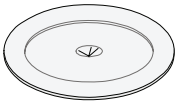
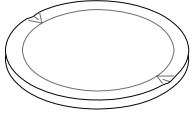

Council directive 73/23/EEC      EN60950      Safety of Information Technology Equipment

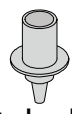
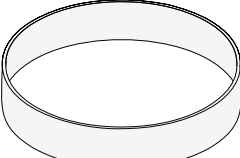
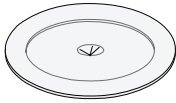
- The CE mark is an official mandatory European marking.  
Please note that any electronic product must comply with local laws and regulations when sold or used anywhere outside Europe.

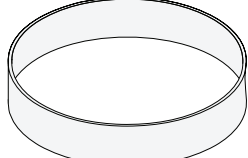
## 2. Unpacking The Balance

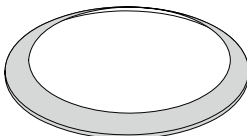
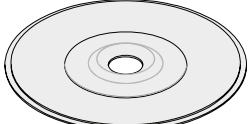
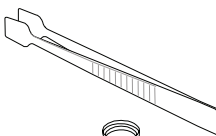
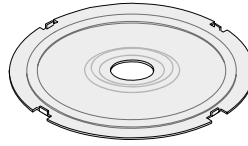
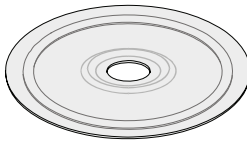
Unpack the balance carefully. Keep the packing material to be used for transporting the balance in the future. See the illustrations to confirm that everything is contained.

### Parts For Each Products

| BM-22, BM-20   | BM-252  | BM-500, BM-300, BM-200   |
|--|---|--|
| <br>Small weighing pan for filter <br>Large weighing pan for filter  | <br>Weighing pan <br>Pan support | <br>Weighing pan      |
| <br>Weighing pan <br>Pan support <br>Test tube holder   | <br>Fine range ring   | <br>Pan support       |
| <br>Small fine range ring <br>Fine range ring  | <br>Breeze break ring   | <br>Breeze break ring |
| <br>Dust plate <br>Tweezers AX-MX-36  | <br>Dust plate  | <br>Dust plate       |
| <br>φ15, 0.8ml<br>Large <br>φ12, 0.3ml<br>Medium <br>φ8, 0.05ml<br>Small<br>Round aluminum analytical pans (each 10 pieces) |   |  |

### Common Parts

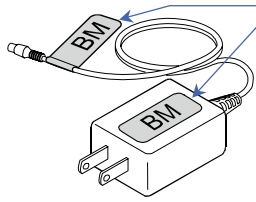

AC adapter  
**Note**  
Please confirm that the AC adapter type is correct for your local voltage and receptacle type.

Position of placing AC adapter labels

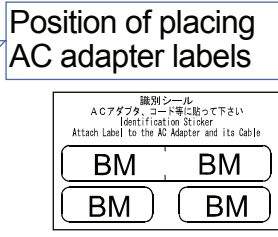

AC adapter labels

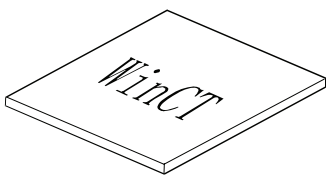

Windows communication software (WinCT)

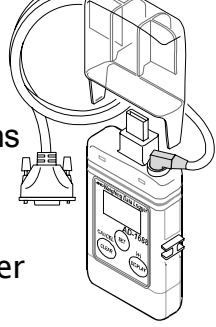

D-sub 9pins

Data logger AD-1688  
The weighing data can be stored when connecting the data logger directly.

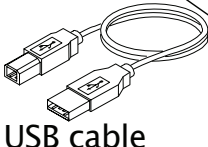

USB cable

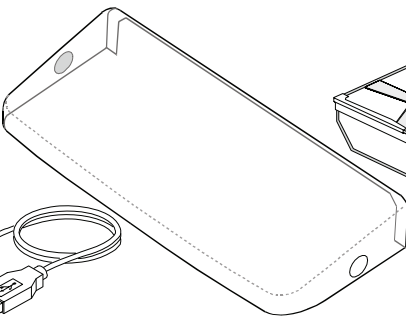

Display cover

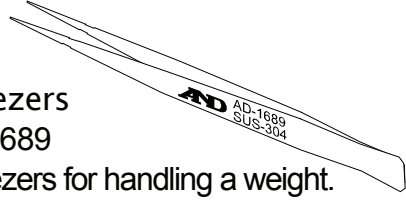

Tweezers AD-1689  
Tweezers for handling a weight. Use it to avoid temperature changes due to having your hand in the weighing chamber, thus to perform accurate calibration.

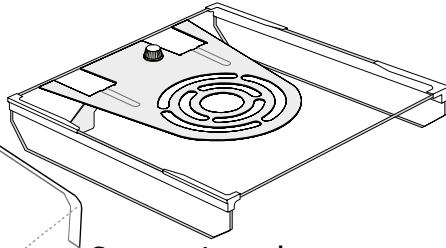

Separation plate  
If unnecessary, remove it.



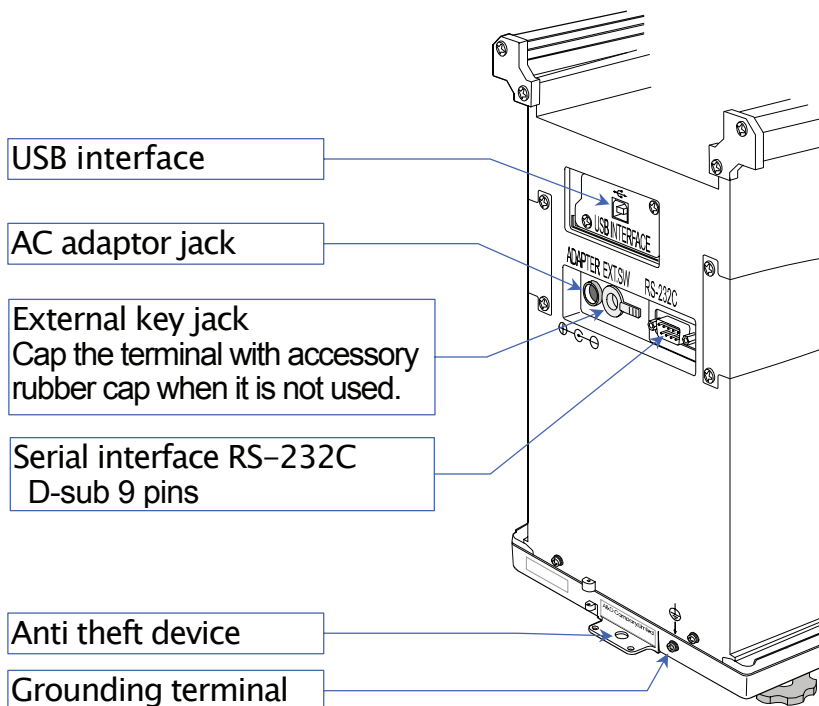
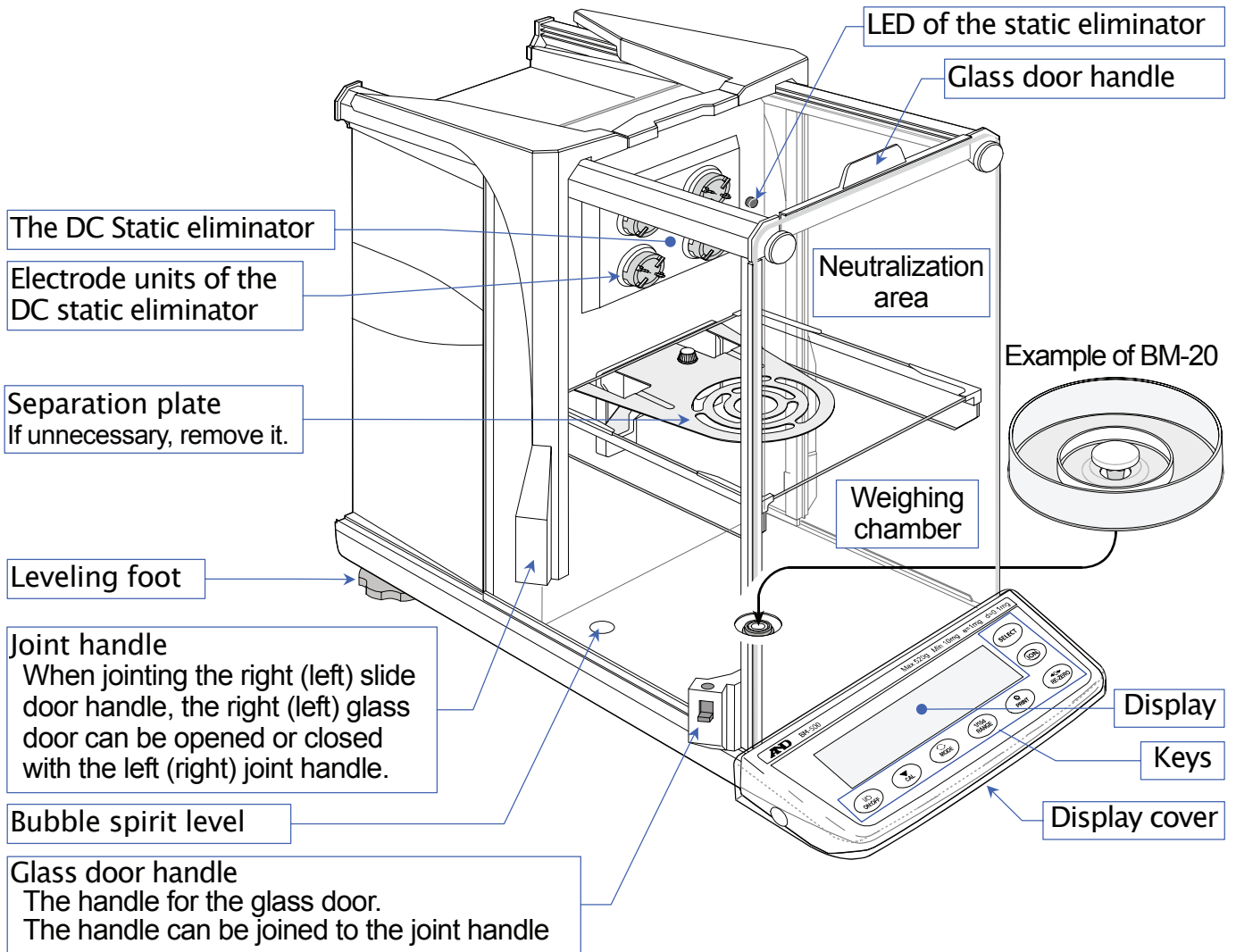

# 3. Installing The Balance And Precautions

## 3.1. Installing The Balance

Step 1 Refer to "3.2. Precautions Before Use (Environmental Condition And Preparations)" concerning the place to install the balance. Place the balance on a firm weighing table.

Step 2 Assemble the weighing pan and other parts in the weighing chamber, in accordance with the product type and use.

### BM-500, BM-300, BM-200

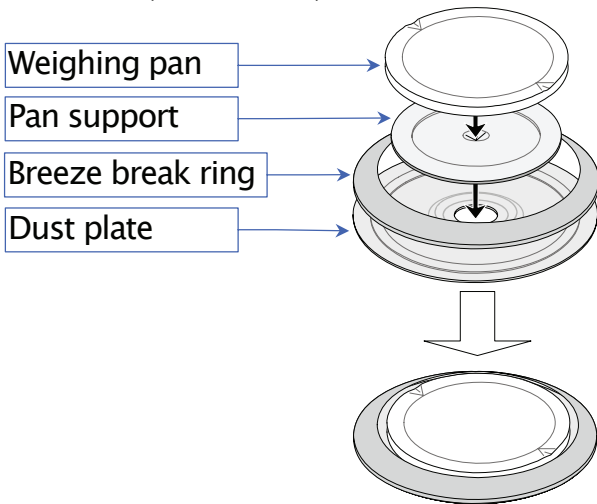

### BM-252

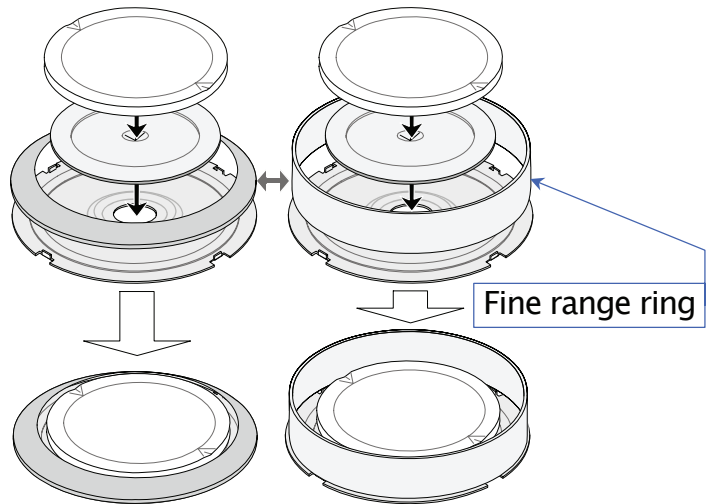

Use the fine range ring to avoid errors caused by drafts when weighing with a minimum display of 0.01 mg.

### BM-22, BM-20

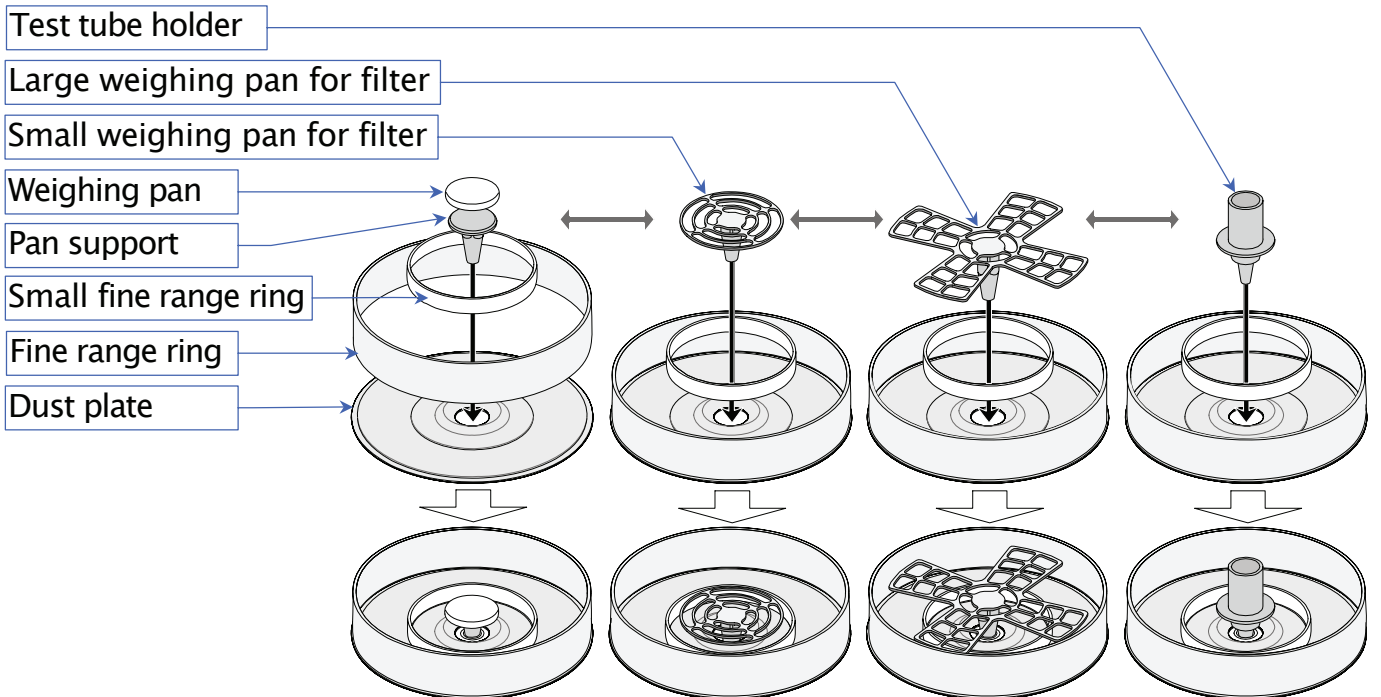

Choose the weighing pan to adapt to the filter size.

Use the holder for micro tube or test tube of  $\phi 12$  mm or less.

- Step 3 If the separation plate is not necessary, remove the screw and take it off. Refer to next page "The Separation Plate".
- Step 4 Adjust the level of the balance using the leveling feet.
- Step 5 Confirm that the AC adaptor type is correct for your local voltage and power receptacle type.
- Step 6 Connect the specified AC adaptor to the balance. Warm up the balance for at least one hour with nothing on the weighing pan.
- Step 7 Confirm correct weighing. If necessary, calibrate the balance. Refer to "8. Calibration".

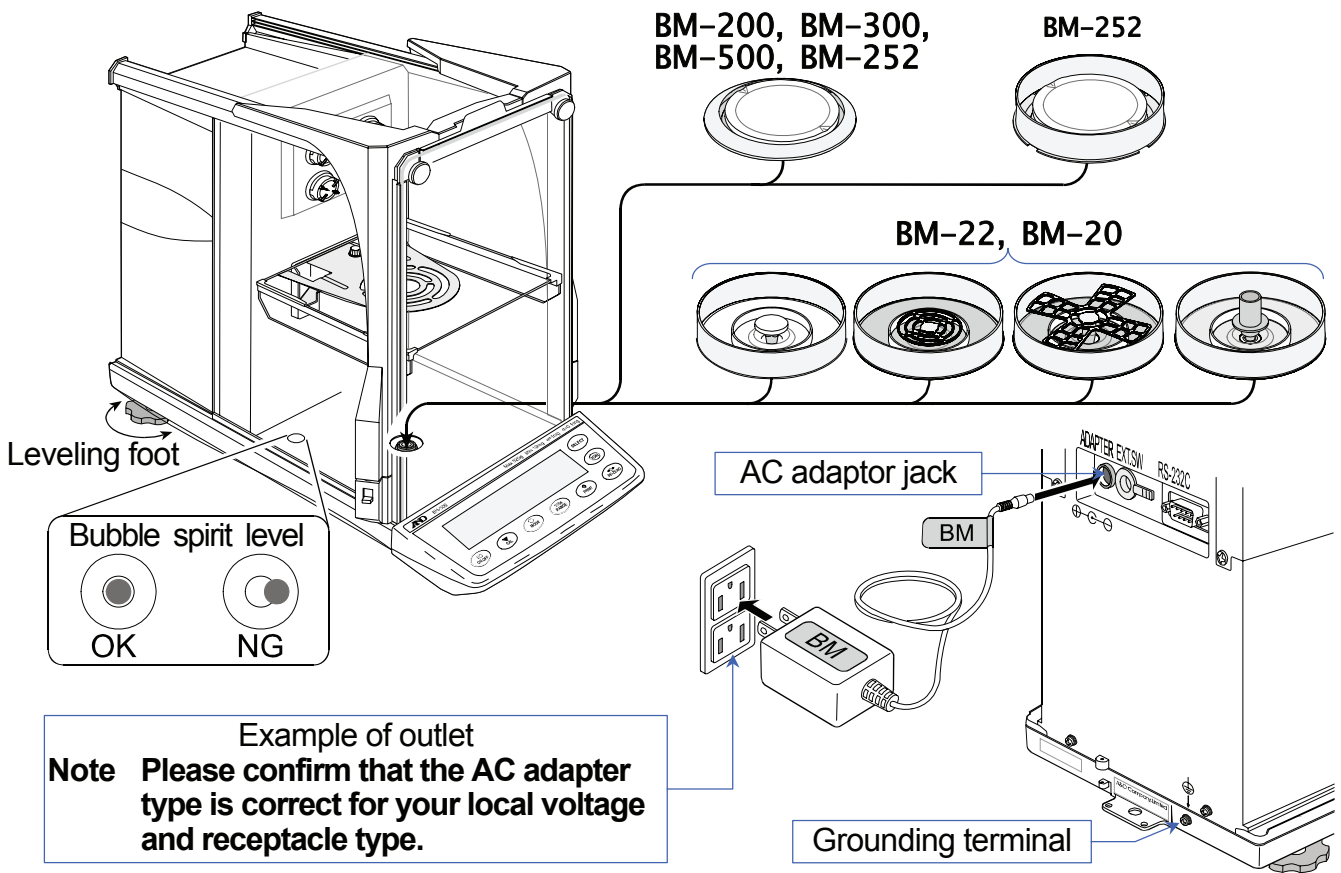
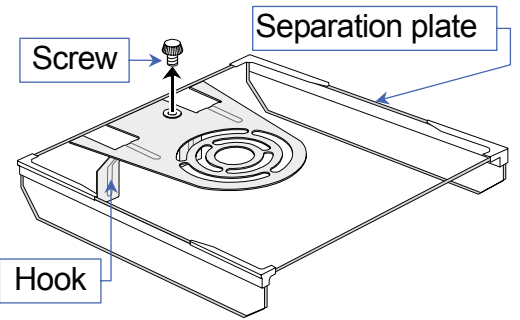

## The Separation Plate

**Note:** Take care that the separation plate is not broken when operating it.

### Removing the Separation Plate

- Step 1 Support the separation plate and remove the screw from the plate.
- Step 2 Lift the plate and remove hooks.
- Step 3 Rotate the plate on the axis of the back edge. Rotate the plate on the axis of the front edge.
- Step 4 Remove the plate from the chamber.

### Attaching the Separation Plate

Use the arrows in reverse to attach the plate.

- Step 5 Insert the plate into the chamber. (Reversed Step 4)
- Step 6 Rotate the plate on the axis of the front edge. Level the plate. (Reversed Step 3)
- Step 7 Insert hooks and hook the plate. (Reversed Step 2)
- Step 8 Install and fix the screw. (Reversed Step 1)

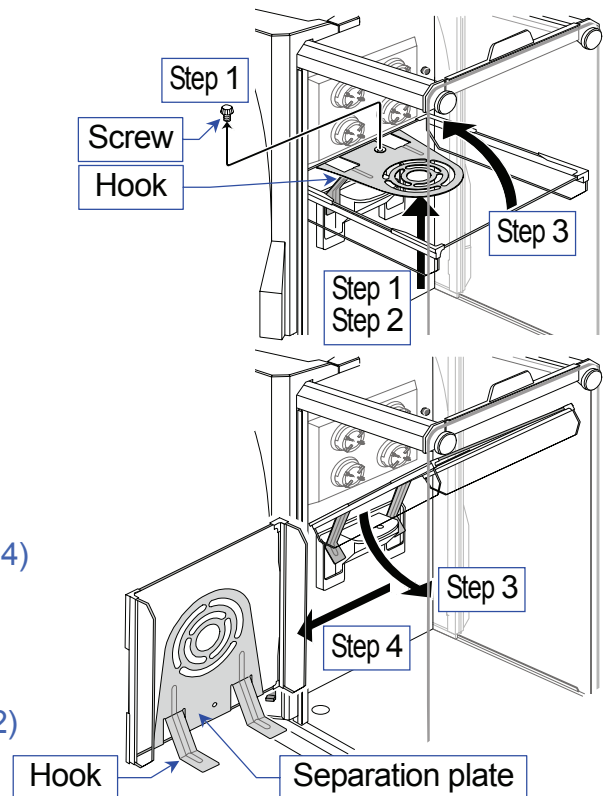

## 3.2. Precautions Before Use (Environmental Condition And Preparations)

To ensure that you get the most from your balance, please try to follow these conditions as closely as possible. Consider these conditions for **BM-20** and **BM-22** that are sensitive instrument specially.

- The best operating temperature is about 20°C / 68°F at about 50% Relative Humidity.
- The weighing room should be free of dust.
- The weighing table should be solid and free from vibration, drafts (such as frequently opening doors or windows) and as level as possible. We recommend to use the anti-vibration table (**AD-1670**) and remote controller (**AD-8922A**) for **BM-20** and **BM-22**.
- Do not install the balance where it will be subject to vibration. Corners of rooms are best.
- Do not install the balance near a heater, air conditioner, or in a breeze.
- Do not install the balance in direct sunlight and excessive temperature changes.
- Do not use the balance near other equipment which produces magnetic fields.
- Adjust the level of the balance using the leveling feet.
- Please warm-up the balance for at least one hour. Plug-in the AC adapter as usual.
- Calibrate the balance before using and after moving it to another location.
- Ensure a stable power source when using the AC adapter.

**⚠ Do not place or use the balance where there is flammable or corrosive gas present.**

### 3.3. Cautions During Use (For Precision Weighing)

Note the following items to get accurate weighing data.

- Discharge static electricity from the weighing material. When weighing sample (plastics, insulator, etc.) could have a static charge, the weight value is influenced. Ground the balance, and
  - Eliminate the static electricity using the built-in static eliminator.
  - Try to keep the ambient humidity at or above 45%RH in the room.
  - Use a metal shield case.
  - Wipe a charged material (plastic sample etc.) with a damp cloth.
- This balance uses a strong magnet as part of the balance assembly, so please use caution when weighing magnetic materials. If there is a problem, use the underhook (on the bottom of the balance) to suspend the material away from the influence of the magnet.
- Eliminate temperature differences between the weighed sample and the environment. When a sample is warmer (cooler) than the ambient temperature, the sample will appear lighter (heavier) than the true mass. This error is due to the rising (falling) draft next the sample. Do not touch the sample directly with your hand. Use tweezers or other tools.
- Do not drop things upon the weighing pan, or place a weight beyond the range of the balance on the weighing pan.
- Make each weighing gently and quickly to avoid errors due to changes in the environmental conditions.
- We recommend that the **fine range ring** and **separation plate** are used to avoid weighing error caused by drafts when **BM-252** displays a weighing value in unit of 0.01 mg (minimum display: 0.01 mg).
- We recommend that the **small fine range ring**, **fine range ring** and **separation plate** are used to avoid weighing error caused by drafts when **BM-22** and **BM-20** display a weighing value in unit of 0.01 mg and 0.001 mg (minimum display: 0.01 mg and 0.001 mg).
- Take into consideration the affect of air buoyancy on a sample when more accuracy is required.
- Do not use a sharp instrument (such as a pencil or ball point pen) to press the keys, use your finger only.
- Press the **RE-ZERO** key before each weighing to prevent possible errors.
- Avoid foreign matter (dust, liquid or metal fragments) that could get inside the balance.
- Operate your balance gently. Shorten the operation time as much as possible (Opening and closing door, putting and removing sample). Use a pair of tweezers to avoid temperature changes due to heat from inserting your hand into the weighing chamber.

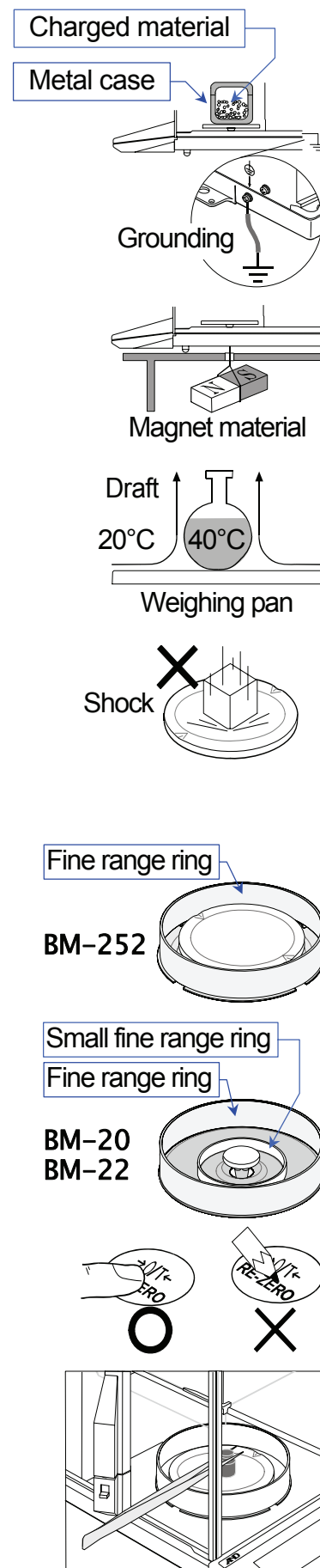

### 3.4. Cautions After Use (Management Of The Balance)

- Avoid mechanical shock to your balance.
- Do not disassemble the balance. Contact your local A&D dealer if your balance needs service or repair.
- Do not use solvents to clean the balance. For best cleaning, wipe with a dry lint free cloth or a lint free cloth that is moistened with warm water and a mild detergent.
- Avoid foreign matter (dust, liquid or metal fragments) that could get inside the balance.

### 3.5. Cautions For Power Supply

- Do not remove the AC adapter while the internal mass is in motion, for example, right after the AC adapter is connected, or during calibration using the internal mass.  
If the AC adapter is removed under the conditions described above, the internal mass will be left unsecured, that may cause mechanical damage when the balance is moved.  
Before removing the AC adapter, confirm that zero is displayed in the weighing mode, then press the **ON:OFF** key.
- When the AC adapter is connected, the balance is in the standby mode if the standby indicator is on. This is a normal state and does not harm the balance. For accurate weighing, we recommend that you always plug in your balance so it can warm up.  
Connect the AC adapter for **BM-22** and **BM-20** normally.

# 4. Display Symbols And Key Operation

## Display

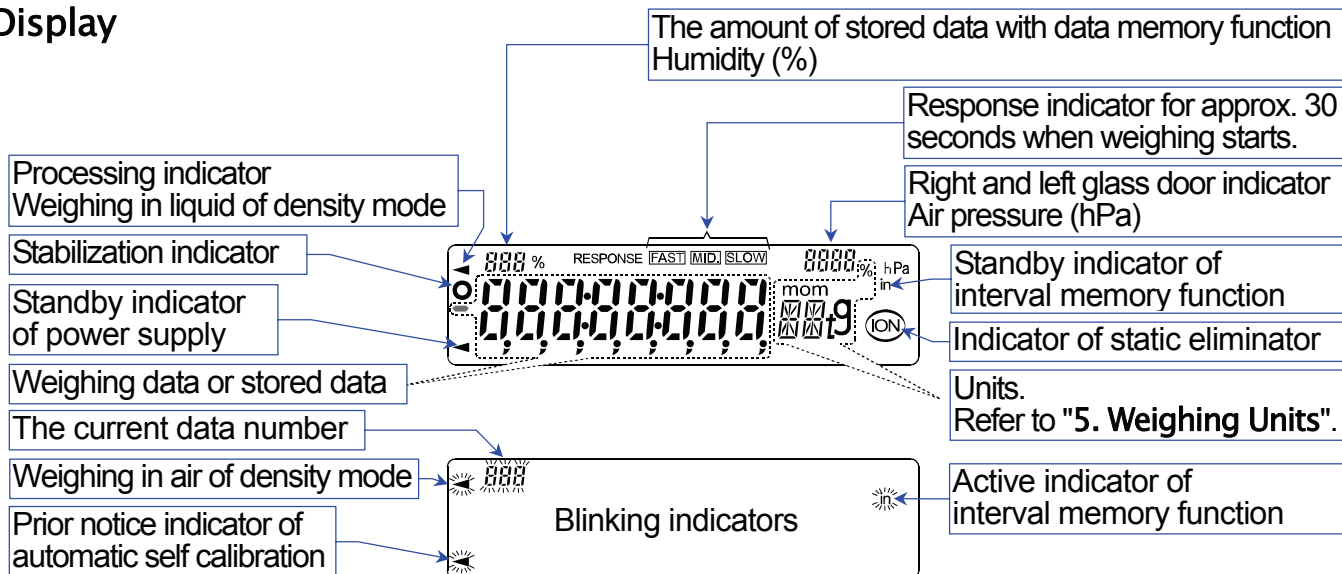

The interval memory function is used to store periodical weighing data. Refer to "12. Data Memory".

## Key Operation

- Press and release the key immediately or "Click the key" .....
- Press and hold the key .....

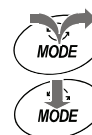

| Key | When pressed and released  | When pressed and held  |
|-----|--|--|
|     | The key to turn the display ON and OFF. The standby indicator is displayed when the display is turned off. The weighing mode is enabled when the display is turned on. This key is available anytime. Pressing the key during operation will interrupt the operation and turn the display OFF. |  |
|     | The key to perform calibration using the internal mass.  | The key to display other items of the calibration menu.  |
|     | The key to switch the preset weighing units stored in the function table. Refer to "5. Weighing Units".  | The key to perform automatic response adjustment.  |
|     | <ul style="list-style-type: none"> <li>□ In the weighing mode, the key to turn the minimum weighing value ON and OFF.</li> <li>□ In the counting or percent mode, the key to enter the sampling mode.</li> </ul>   | The key to enter the function table mode or repeatability test mode. Refer to "10. Function Table" or "6.7. Repeatability Test".   |
|     | The key to outputs the weighing data to a printer or personal computer (or store it in memory) depending on the function table settings. (Factory setting = output)  | <ul style="list-style-type: none"> <li>□ No function at factory setting.</li> <li>□ By changing the function table:                             <ul style="list-style-type: none"> <li>■ "Title block" and "End block" for GLP report are output.</li> <li>■ The data memory menu is displayed.</li> </ul> </li> </ul> |
|     | The key to set the display to zero.  |  |
|     | The key to turn the static eliminator ON and OFF.  |  |
|     | The key to monitor the date and time, and the environmental sensors (temperature, humidity, air pressure), for several seconds. Refer to "6.6. Monitoring Clock and Environmental Sensors".  |  |

## 5. Weighing Units

### 5.1. Units

- The units and weighing modes can be selected and stored in the function table as described in "5.2. Storing The Active Units".  
The sequence of displaying them can be arranged to fit the frequency of use.  
They are stored and are maintained in non-volatile memory, even if the AC adapter is removed.
- If the law in your area permits, you may use all of the units. You can disable the units that you don't regularly use. And you are able to turn them back on.
- If a weighing mode (or unit of mass) has been turned off, that mode or unit will be missing in the sequence. Tael has four varieties, one of which can be selected and installed at the factory.
- Press the **MODE** key to select a unit or mode for weighing.
- For details about the units and modes, see the table below:

| Name (unit, mode)            | Abbreviation | Display unit                       | Conversion factor |
|------------------------------|--------------|------------------------------------|-------------------|
| Gram                         | g            | g                                  | 1 g               |
| Milligram                    | mg           | mg                                 | 0.001 g           |
| Counting mode                | PC           | PC                                 | –                 |
| Percent mode                 | %            | %                                  | –                 |
| Ounce (Avoir)                | oz           | oz                                 | 28.349523125 g    |
| Troy Ounce                   | ozt          | ozt                                | 31.1034768 g      |
| Metric Carat                 | ct           | ct                                 | 0.2 g             |
| Momme                        | mom          | mom                                | 3.75 g            |
| Pennyweight                  | dwt          | dwt                                | 1.55517384 g      |
| Grain (UK)                   | GN           | GN                                 | 0.06479891 g      |
| Tael (HK general, Singapore) | tl           | tL                                 | 37.7994 g         |
| Tael (HK jewelry)            |              |                                    | 37.429 g          |
| Tael (Taiwan)                |              |                                    | 37.5 g            |
| Tael (China)                 |              |                                    | 31.25 g           |
| Tola (India)                 | t            | t                                  | 11.6638038 g      |
| Messghal                     | m            | m                                  | 4.6875 g          |
| Density mode                 | DS           | Refer to "14. Density Measurement" |                   |

- Density mode
  - To use the density mode, it must be stored in the function table as described on page 17.  
For details about this mode, refer to "14. Density Measurement".
  - To select this mode, press the **MODE** key until the processing indicator  blinks with the unit "g" displayed.



## Capacity And Minimum Display For BM-252, BM-500, BM-300, BM-200

- The tables below indicate the weighing capacity and the minimum display for each balance.

| Unit                         | BM-500   | BM-300 | BM-200 | Minimum display |
|------------------------------|----------|--------|--------|-----------------|
|                              | Capacity |        |        |                 |
| Gram                         | 520      | 320    | 220    | 0.0001          |
| Milligram                    | 520000   | 320000 | 220000 | 0.1             |
| Ounce (Avoir)                | 18.34    | 11.29  | 7.76   | 0.00001         |
| Troy Ounce                   | 16.72    | 10.29  | 7.07   | 0.00001         |
| Metric Carat                 | 2600     | 1600   | 1100   | 0.001           |
| Momme                        | 138.7    | 85.3   | 58.7   | 0.0001          |
| Pennyweight                  | 334.4    | 205.8  | 141.5  | 0.0001          |
| Grain (UK)                   | 8024     | 4938   | 3395   | 0.002           |
| Tael (HK general, Singapore) | 13.76    | 8.47   | 5.82   | 0.00001         |
| Tael (HK jewelry)            | 13.89    | 8.55   | 5.88   | 0.00001         |
| Tael (Taiwan)                | 13.87    | 8.53   | 5.87   | 0.00001         |
| Tael (China)                 | 16.64    | 10.24  | 7.04   | 0.00001         |
| Tola (India)                 | 44.58    | 27.44  | 18.86  | 0.00001         |
| Messghal                     | 110.9    | 68.3   | 46.9   | 0.0001          |

| Unit                         | BM-252   |                 |
|------------------------------|----------|-----------------|
|                              | Capacity | Minimum display |
| Gram                         | 250      | 0.00001         |
| Milligram                    | 250000   | 0.01            |
| Ounce (Avoir)                | 8.82     | 0.000001        |
| Troy Ounce                   | 8.03     | 0.000001        |
| Metric Carat                 | 1250     | 0.0001          |
| Momme                        | 66.67    | 0.00001         |
| Pennyweight                  | 160.7    | 0.00001         |
| Grain (UK)                   | 3858     | 0.0002          |
| Tael (HK general, Singapore) | 6.61     | 0.000001        |
| Tael (HK jewelry)            | 6.68     | 0.000001        |
| Tael (Taiwan)                | 6.67     | 0.000001        |
| Tael (China)                 | 8.00     | 0.000001        |
| Tola (India)                 | 21.43    | 0.000001        |
| Messghal                     | 53.3     | 0.00001         |

## Capacity And Minimum Display For BM-22, BM-20

- **BM-22** is equipped the precision range and standard range of the smart range function.

| Unit                         | BM-20           |                 |
|------------------------------|-----------------|-----------------|
|                              | Precision range |                 |
|                              | Capacity        | Minimum display |
| Gram                         | 22              | 0.000001        |
| Milligram                    | 22000           | 0.001           |
| Ounce (Avoir)                | 0.776           | 0.0000001       |
| Troy Ounce                   | 0.707           | 0.0000001       |
| Metric Carat                 | 110             | 0.00001         |
| Momme                        | 5.87            | 0.000001        |
| Pennyweight                  | 14.15           | 0.000001        |
| Grain (UK)                   | 339.5           | 0.00002         |
| Tael (HK general, Singapore) | 0.582           | 0.0000001       |
| Tael (HK jewelry)            | 0.588           | 0.0000001       |
| Tael (Taiwan)                | 0.587           | 0.0000001       |
| Tael (China)                 | 0.704           | 0.0000001       |
| Tola (India)                 | 1.886           | 0.0000001       |
| Messghal                     | 4.69            | 0.000001        |

| Unit                         | BM-22           |                 |                |                 |
|------------------------------|-----------------|-----------------|----------------|-----------------|
|                              | Precision range |                 | Standard range |                 |
|                              | Capacity        | Minimum display | Capacity       | Minimum display |
| Gram                         | 5.1             | 0.000001        | 22             | 0.00001         |
| Milligram                    | 5100            | 0.001           | 22000          | 0.01            |
| Ounce (Avoir)                | 0.180           | 0.0000001       | 0.776          | 0.000001        |
| Troy Ounce                   | 0.164           | 0.0000001       | 0.707          | 0.000001        |
| Metric Carat                 | 25.5            | 0.00001         | 110            | 0.0001          |
| Momme                        | 1.36            | 0.000001        | 5.87           | 0.00001         |
| Pennyweight                  | 3.28            | 0.000001        | 14.15          | 0.00001         |
| Grain (UK)                   | 78.71           | 0.00002         | 339.5          | 0.0002          |
| Tael (HK general, Singapore) | 0.135           | 0.0000001       | 0.582          | 0.000001        |
| Tael (HK jewelry)            | 0.136           | 0.0000001       | 0.588          | 0.000001        |
| Tael (Taiwan)                | 0.136           | 0.0000001       | 0.587          | 0.000001        |
| Tael (China)                 | 0.163           | 0.0000001       | 0.704          | 0.000001        |
| Tola (India)                 | 0.437           | 0.0000001       | 1.886          | 0.000001        |
| Messghal                     | 1.09            | 0.000001        | 4.69           | 0.00001         |

## 5.2. Storing Active Units

- The units and modes can be selected and stored in the function table. The sequence of displaying them can be arranged to fit the frequency of use. The units stored are maintained in non-volatile memory, even if the AC adapter is removed.

- Press and hold the **RANGE** key until **bR5FnC** of the function table is displayed in the weighing mode, then release the key.
- Press the **RANGE** key several times to display **Unit**.
- Press the **PRINT** key to enter the unit selection mode.
- Specify a unit or mode in the order to be displayed using the following keys.
  - RANGE** key .....To display the units sequentially.
  - RE-ZERO** key .....To specify a unit or mode.

The indicator **o** appears when the displayed unit or mode is specified.

### Examples

| Unit          |    | Display          |
|---------------|----|------------------|
| Gram          | g  | <b>o</b> Unit g  |
| Milligram     | mg | <b>o</b> Unit mg |
| Counting mode | PC | <b>o</b> Unit PC |
| Percent mode  | %  | <b>o</b> Unit %  |
| Density mode  | DS | <b>o</b> Unit DS |

- Press the **PRINT** key to store the units or modes. The balance displays **End** and then displays the next menu item of the function table.
- Press the **CAL** key to exit the function table. Then the balance returns to the weighing mode with the selected unit.

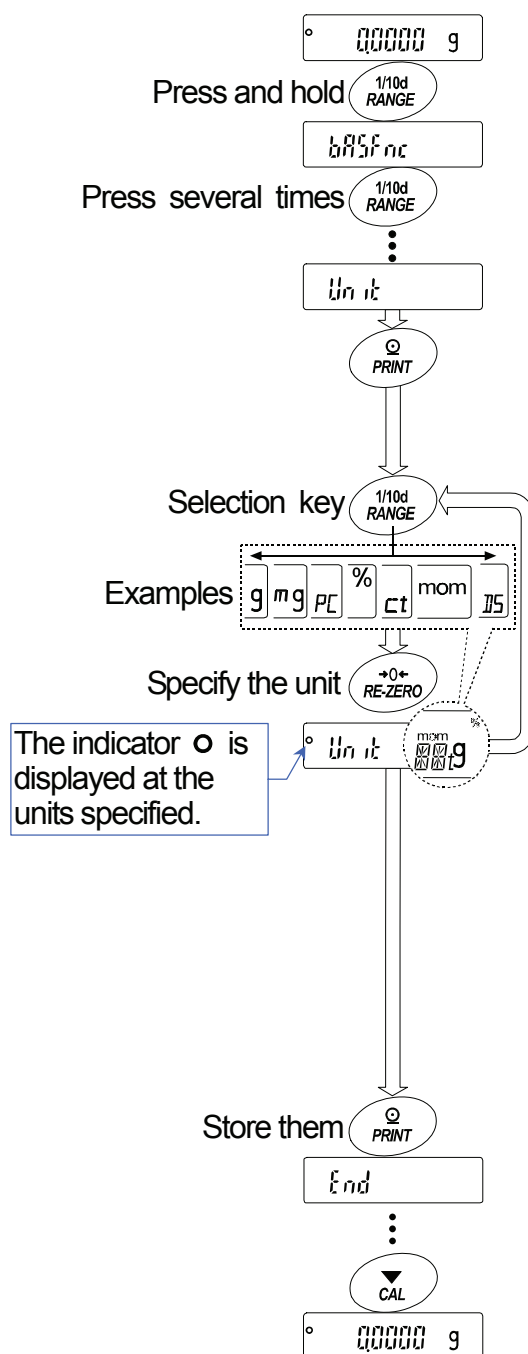

## 5.3. Selecting Unit And Weighing Mode

- Preset the sequence of displaying units and weighing modes to fit the frequency of use. Refer to "5.2 . Storing The Active Units".
- Pressing the **MODE** key in the weighing mode, the unit and weighing mode can be displayed in order.
- **BM-22** and **BM-20** are preset units in the factory. **mg** (Milligram), **g** (Gram) is displayed in order.
- For **BM-252**, **BM-500**, **BM-300** and **BM-200** are preset units in the factory. **g** (Gram), **mg** (Milligram) is displayed in order.
- Density mode
  - To use the density mode, it must be stored in the function table as described on page 17. Refer to "14. Density Measurement" for details about the mode.
  - To select this mode, press the **MODE** key until the processing indicator  blinks with the unit "g" displayed.

The unit sequence of the factory settings.  
Turning on the display.

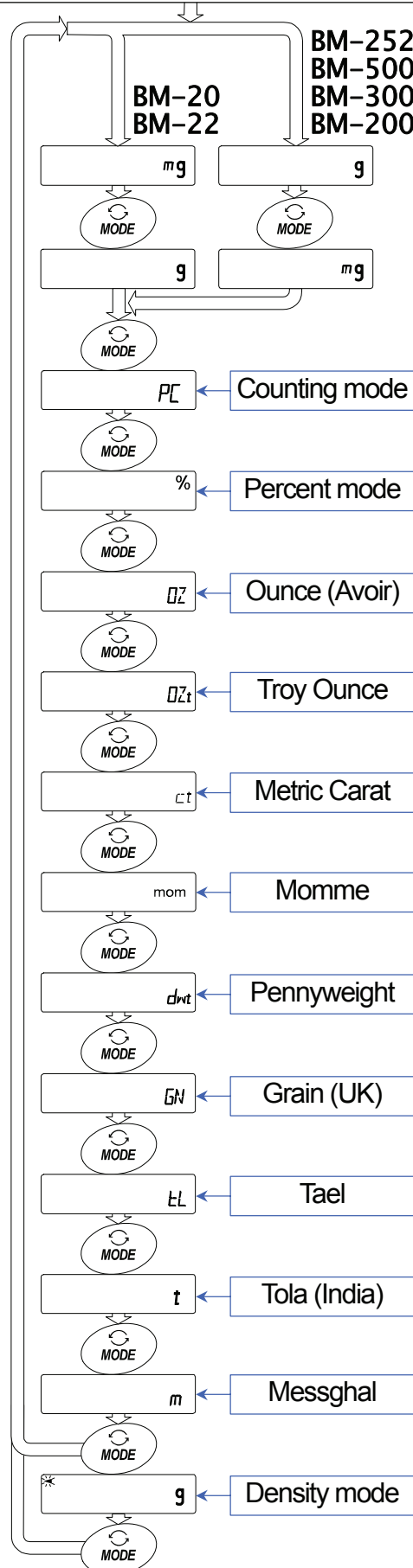

### 5.3.1. Unit Setting Example

The example below sets the units in the order with g (gram) as the first unit followed by PC (counting mode).

- 1 Press and hold the **RANGE** key until **bASFnC** of the function table is displayed in the weighing mode, then release the key.
- 2 Press the **RANGE** key several times to display **Unit**.
- 3 Press the **PRINT** key to enter the unit selection mode.
- 4 Press the **RE-ZERO** key to specify the unit of g. The stabilization indicator **○** appears when the unit is specified.
- 5 Press the **RANGE** key several times to display **Unit PC**.
- 6 Press the **RE-ZERO** key to specify the unit of pcs. The stabilization indicator **○** appears when the unit is specified.
- 7 Press the **PRINT** key to store the units. The balance displays **End** and then displays the next menu item of the function table.
- 8 Press the **CAL** key to exit the function table. Then the balance returns to the weighing mode with g, the unit selected first.
- 9 Press the **MODE** key to switch between g and PC.

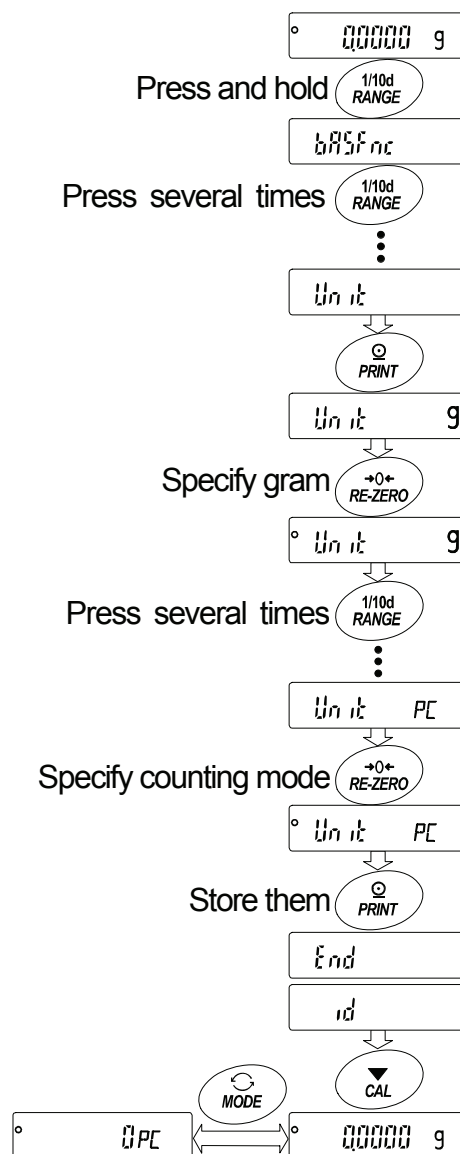

## 6. Weighing

### Precautions for the weighing operation

- Press the **RE-ZERO** key each time, before placing a sample on the weighing pan, to prevent possible errors.
- Place a sample in the center of the weighing pan gently.
- Temperature changes during measurement may cause weighing error.
- Shorten the operation time as much as possible. (Opening and closing door, putting and removing sample)
- Use a pair of tweezers to avoid a temperature change due to having your hand in the weighing chamber.
- Material with an electrostatic charge or that is magnetic may cause a weighing error.
- Do not press keys with a sharp instrument (such as a pencil or ball point pen).
- Do not drop things on the pan, or place a weight on the pan that is beyond the weighing range.
- Calibrate your balance periodically to maintain weighing accuracy. Refer to section "8. Calibration".
- Keep the area clean and dry.
- Consider section "3. Precautions" for the weighing operation.
- For precision weighing, keep the AC adapter connected to the balance.

### 6.1. Basic Operation (Gram Mode)

Refer to section "4. Display symbols and Key operation" before operation.

**Note** When turning on the balance with a tare weight placed on the pan, the balance automatically displays the zero display.

- 1 Turn on the balance using the **ON:OFF** key.
- 2 Select a preset unit using the **MODE** key, if necessary.
- 3 Place the tare (container) on the weighing pan, if necessary.  
Press the **RE-ZERO** key to cancel the tare weight.  
Then zero is displayed.  
Tare : A vessel placed on the pan, but not to be included in the weighing data.  
Example: Container.
- 4 Place a sample on the pan or in the container.  
Close the door.
- 5 Wait for the stabilization indicator  to be displayed, then read the value.
- 6 Remove the sample and container from the pan.

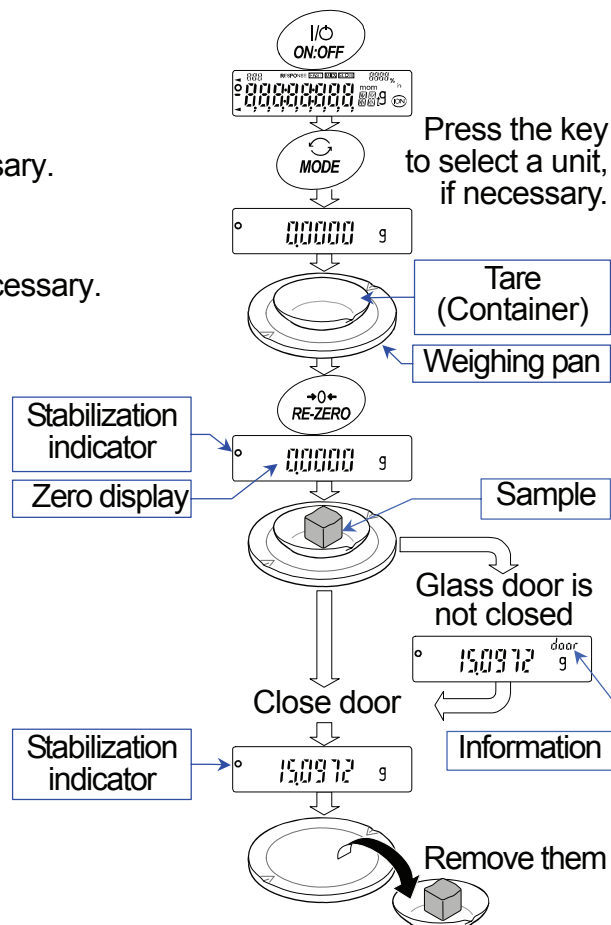

## 6.2. Smart Range For BM-22

- The smart range for **BM-22** consists of the standard range and precision range (high resolution).
- Smart range function
  - These ranges can be switched by the weighing value automatically.
  - When placing the tare weight within the standard range, if pressing the **RE-ZERO** key, the weighing sample can be weighed within the precision range.
  - When pressing **RANGE** key, the current range is fixed to the standard range.

### Example

- 1 Press the **RE-ZERO** key to use the precision range.  
The balance displays zero.
- 2 Place the container (tare) on the weighing pan.  
When mass of the container (tare) is within the standard range, the current range is automatically switched to the standard range.
- 3 Press the **RE-ZERO** key to use the precision range.  
The balance displays zero.
- 4 Place the weighing sample in the container (tare).  
When the sample is within the precision range, the weighing value can be read in high resolution.

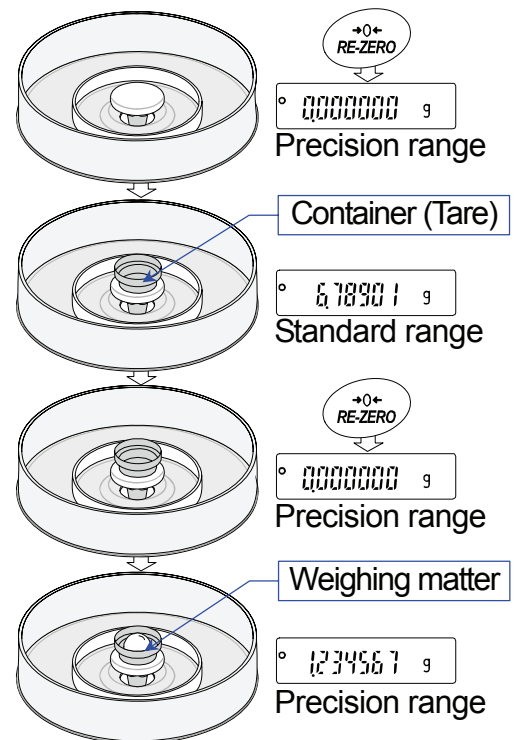

### Precision Range And Standard Range For BM-22

| Unit      | Precision range          | Standard range            |
|-----------|--------------------------|---------------------------|
| Milligram | 0.000 mg to 5100.009 mg  | 5100.01 mg to 22000.84 mg |
| Gram      | 0.000000 g to 5.100009 g | 5.10001 g to 22.00084 g   |

Refer to page 14 for other units.

## 6.3. Counting Mode (PC)

- This is the mode to determine the number of objects in a sample based on the standard sample unit mass. The unit mass means an average mass of the samples. The smaller the variation in the samples, the more accurate the count will be. The balance is equipped with the Automatic Counting Accuracy Improvement (ACAI) function to improve the counting accuracy.

### Notes

- Use samples with a unit mass of 1 mg or more for counting.
- If the sample unit mass variable is too large, it may cause a counting error.
- To improve the counting performance, use the ACAI function frequently or divide the samples into several groups and count each group.

### Selecting the counting mode

- 1 Press the **MODE** key to select the unit **PC** (counting mode).

### Storing a sample unit mass (Weighing input mode)

- 2 Press the **RANGE** key to enter the sample unit mass storing mode.

- 3 Select the number of samples using the **RANGE** key.  
It may be set to 10, 25, 50 or 100.

**Advise** A greater number of samples will yield more accurate counting result.

- 4 Place a tare (container) on the weighing pan, if necessary.  
Press the **RE-ZERO** key to cancel the weight (tare).  
The number specified in step 3 appears.

Example: **25 0 PC** is displayed if 25 is selected in step 3.

- 5 Place the number of samples specified on the pan.  
In this example, 25 pieces.

- 6 Wait for the stabilization indicator to be displayed.  
Press the **PRINT** key to calculate and store the unit mass.  
Then the balance displays **25 PC** and is set to count samples with this unit mass. To improve the accuracy of the unit mass, proceed to step 8.

### Notes

- If the balance judges that the mass of the samples is too light to acquire accurate weighing, it displays an error requiring the addition of more samples to the specified number.  
Example: **50 - PC** appears, requiring 25 more samples. Add 25 samples and press the **PRINT** key. When the unit mass is stored correctly, the balance proceeds to the counting mode.
- If the balance judges that the mass of the samples is too light (under 0.0001g) and can not be stored as the unit mass, it displays **Lo**.
- The sample unit mass is stored in non-volatile memory, and is maintained even if the AC adapter is removed.

### Counting Operation

- 7 Place the samples to be counted on the pan.  
Read the result and remove them from the pan.

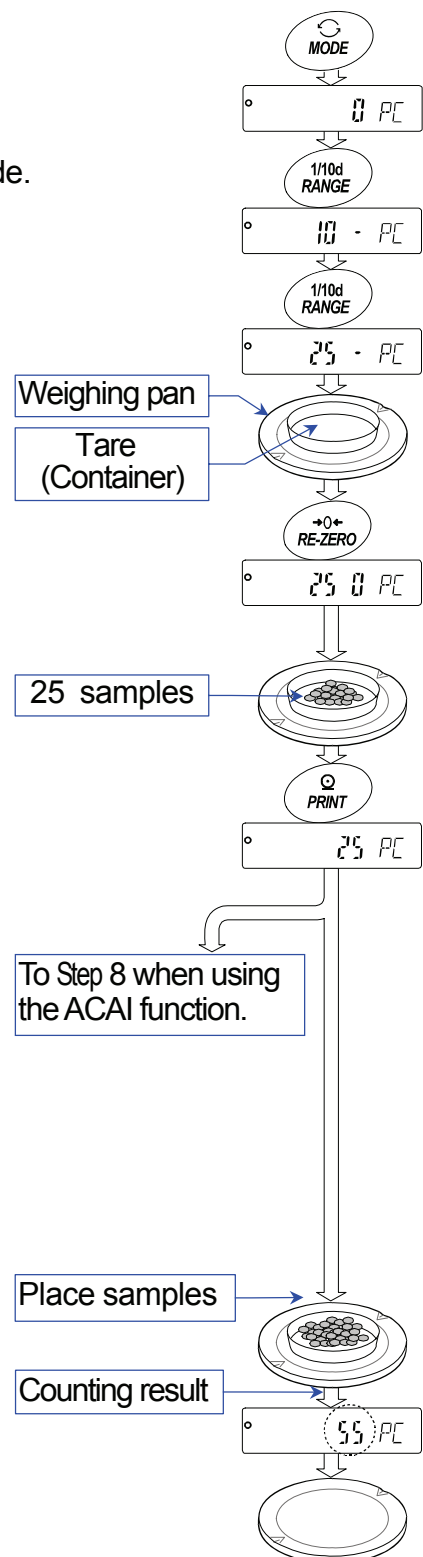



## Counting mode using the ACAI function

The ACAI is a function that improves the accuracy of the unit mass automatically by increasing the number of samples as the counting process.

**ACAI:** Automatic Counting Accuracy Improvement

Proceed to step 8 after storing a unit mass at last page.

- 8 If a few more samples are added, the processing indicator turns on. To prevent an error, add three or more. The processing indicator does not turn on if overloaded. Try to add the same number of samples as displayed.
- 9 The balance re-calculates the unit mass while the processing indicator is blinking. Do not touch the balance or samples on the pan until the processing indicator turns off.
- 10 Counting accuracy is improved when the processing indicator turns off.  
Each time the above operation is performed, a more accurate unit mass will be obtained. There is no definite upper limit to the ACAI range for the number of samples exceeding 100. Try to add the same number of samples as displayed.
- 11 Remove all the samples used in ACAI and proceed with the counting operation using the improved unit mass.

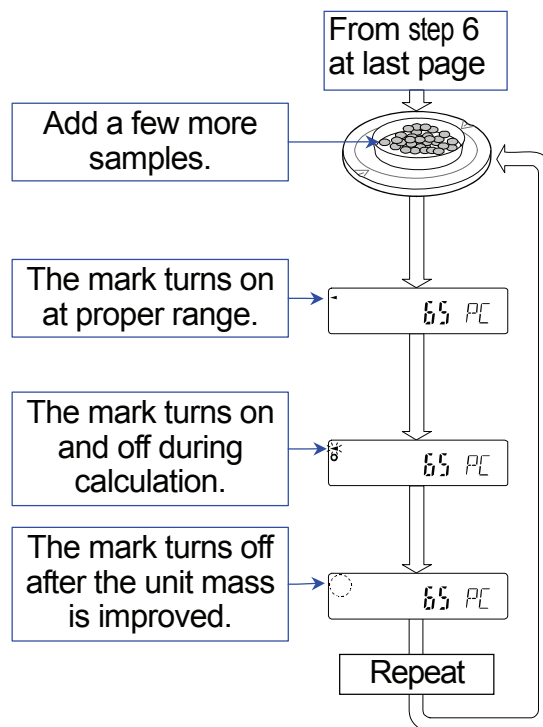

## 6.4. Percent Mode (%)

The percent mode displays the weight value in percentage compared to a 100% reference mass and is used for target weighing or checking the sample variance.

### Selecting the percent mode

- 1 Press the **MODE** key to select the unit **%** (Percent mode).  
If the percent mode can not be selected, refer to "5. Weighing Units".

### Storing the 100% reference mass

- 2 Press the **RANGE** key to enter the 100% reference mass storing mode.  
The balance displays **100.0 %**.
- 3 Place a tare (container) on the weighing pan, if necessary.  
Press the **RE-ZERO** key to cancel the weight (tare).  
The balance displays **100.0 %**.
- 4 Place the sample to be set as the 100% reference mass on the pan or in the container.
- 5 Press the **PRINT** key to store the reference mass.  
The balance displays **10000 %**.

### Note

- The decimal point position can be changed by the 100% mass.

| BM-252, BM-500<br>BM-300, BM-200 |                 | BM-20, BM-22          |                 |
|----------------------------------|-----------------|-----------------------|-----------------|
| 100% mass                        | Minimum display | 100% mass             | Minimum display |
| 0.0100 g to 0.0999 g             | 1 %             | 0.00100 g to 0.0099 g | 1 %             |
| 0.1000 g to 0.9999 g             | 0.1 %           | 0.01000 g to 0.0999 g | 0.1 %           |
| 1.0000 g to                      | 0.01 %          | 0.10000 g to          | 0.01 %          |

- If the balance judges that the mass of the sample is too light (under 0.01g) to be used as a reference, it displays **Lo**.
  - A 100% reference mass can be stored in the non-volatile memory and is maintained even if the AC adapter is removed.
- 6 Remove the sample.

### Reading the percentage

- 7 Place a sample to be compared to the reference mass on the pan. The displayed percentage is based on the 100% reference mass.

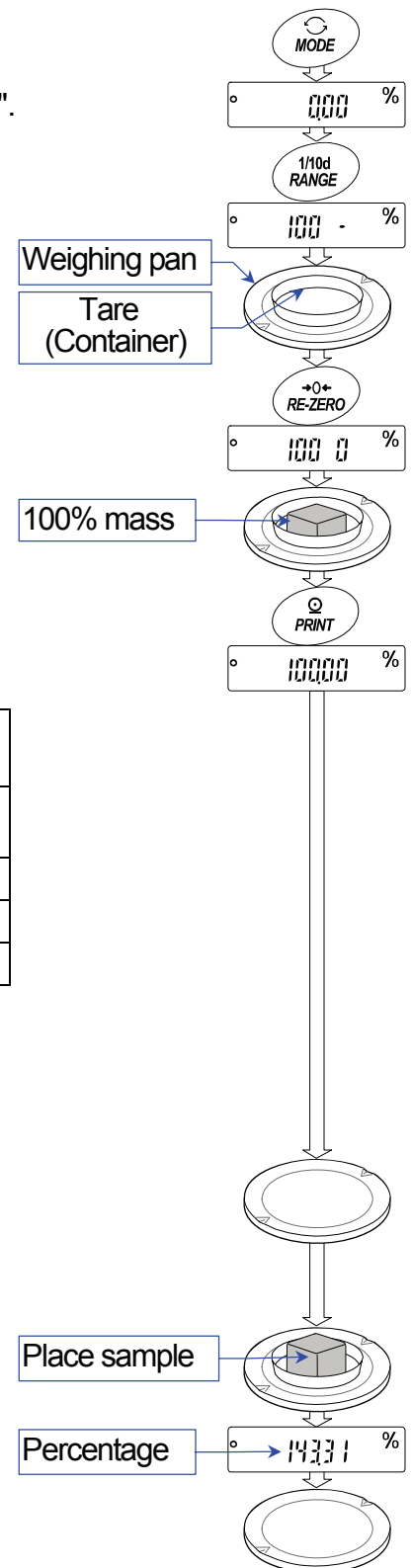

## 6.5. Built-in DC Static Eliminator (Neutralization Device)

The **BM** series is equipped with four DC static eliminator electrode units to neutralize static electricity from a charged weighing sample.

When neutralizing static electricity before weighing, stability can be improved, reducing error.

**Neutralizing ion :** The discharge electrodes of the built-in DC static eliminator continuously generate bipolar ions by corona discharge. Applying these ions to the weighing sample neutralizes the static charge.

**Static electricity :** In general, when the ambient humidity is less than 45%RH, powders, paper, plastic, nonconductors, etc., easily become charged with static electricity. The influence of the static electricity may cause a weighing error of several milligrams. The static eliminator effectively neutralizes the electrical charge.

### Operation

- 1 Place the sample to be weighed on the center (of the metallic circle) of the separation plate to neutralize the static charge.
  - 2 Press the **ION** key to start the neutralization. The **ION** mark and the LED flash. The neutralization will stop after the preset time of "Neutralizing time (ION)" in the function table (the factory setting is 3 seconds).
- The minimum display of **BM-20**, **BM-22** and **BM-252** is switched to 0.1 mg while performing the neutralization.
  - When pressing the **ION** key during the neutralization, the neutralization stops.

### Note

- Keep a space between electrodes and the weighing sample. Placing the sample to close to an electrode may cause the sample to become charged.
- Remove any obstacle between electrodes and the weighing sample.

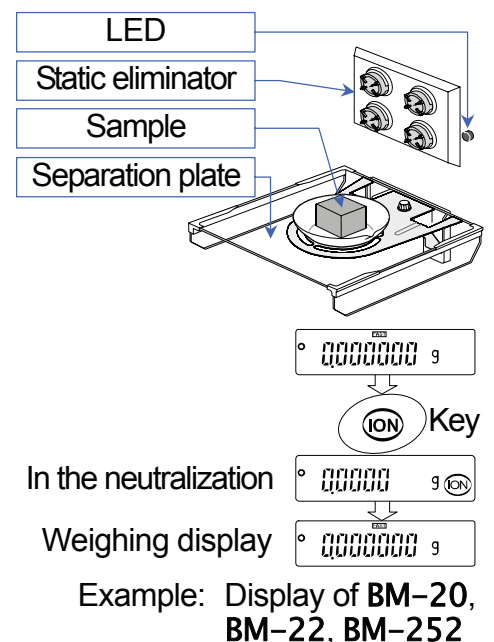

### Maintenance Of The Electrode Unit

- In general, when using the eliminator for a long time, dust and stains may stick to the electrodes. Clean them periodically to maintain performance.
- When pins of the electrode are rubbed down and the neutralization function does not recover after cleaning them, replace the electrodes with four new units. The standard life time is approximately 10000 hours.

### Replacing Electrode Unit

- 1 Turn the electrode unit 45 degrees counterclockwise. Remove it.
- 2 Replace all four units with new ones at the same time.

### Note

Do not remove and clean the electrodes while the **ION** mark and the LED are flashing.

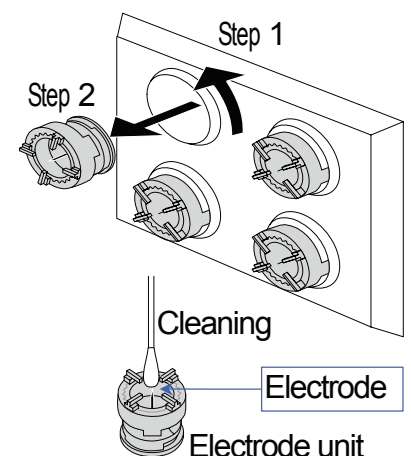

## Remote Control Of The DC Static Eliminator

- When specifying "00" to [AD8922 control] in the function settings ( $8922 \text{ ionFnc } 00$ ), the balance applies the function of the **ION** key to the **MODE** key on the AD-8922.
- When specifying "2" to [External control input ] in the function settings ( $E-5 \text{ ionFnc } 2$ ) and assembling external key plug (**AX-T-314A-S**) and foot switch (**AX-SW128**), the balance applies the function of the **ION** key to the foot switch

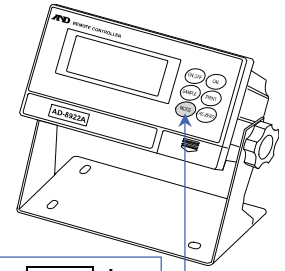

Applies the **ION** key to the **MODE** key on the AD-8922A.

### Example:

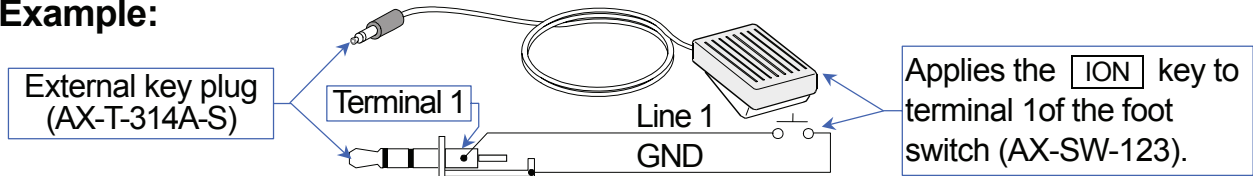

### Description Of The External Key Plug (AX-T-314A-S) (Option)

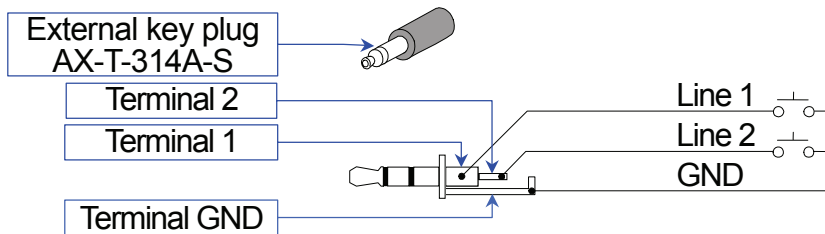

- When specifying [External control input ( $E-5$ )] in [Static eliminator ( $\text{ionFnc}$ )], the following functions can be applied to the external key plug (**AX-T-314A-S**) terminals.

| Static eliminator | External control input | Terminal 1       | Terminal 2         |
|-------------------|------------------------|------------------|--------------------|
| ▪ $\text{ionFnc}$ | $E-5 \ 0$              | <b>PRINT</b> key | <b>RE-ZERO</b> key |
| $\text{ionFnc}$   | $E-5 \ 1$              | <b>PRINT</b> key | <b>ION</b> key     |
| $\text{ionFnc}$   | $E-5 \ 2$              | <b>ION</b> key   | <b>RE-ZERO</b> key |

- factory settings

## 6.6. Monitoring Clock and Environmental Sensors

In the weighing mode, the built-in clock and environmental sensors (temperature, humidity, air pressure) can be monitored and temperature data can be output with the function settings.

### Specifications Of The Environmental Sensors

| Sensor       | Resolution | Measurement range   | Applicable range |
|--------------|------------|---------------------|------------------|
| Temperature  | ±1.5 °C    | 5 °C to 40 °C       | 5 °C to 40 °C    |
| Humidity     | ±10 %      | 0 % to 100 %        |                  |
| Air pressure | ±10 hPa    | 300 hPa to 1100 hPa |                  |

### Caution

- The environmental sensors are built into the case. Therefore, these values are not in accordance with the environmental condition.
- Refer to "17. Specifications" for operating condition of the product.

### Operation

- Press the **SELECT** key in the weighing mode. The current time, date and sensor values (temperature, humidity, air pressure) are displayed for several seconds in order. The balance returns to the weighing mode automatically.
- If pressing the **SELECT** key while displaying current data, the display proceeds to next data.
- If pressing the **CAL** key while displaying current data, the balance returns to weighing mode.

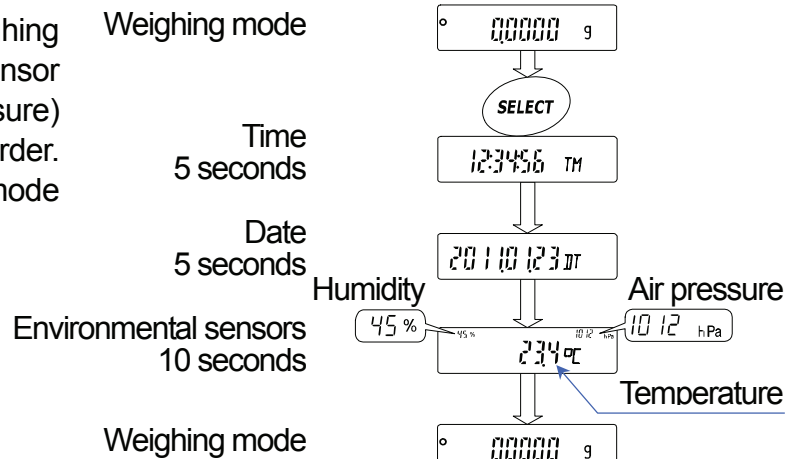

### Note

- If adjusting the built-in clock, refer to "10.7.Clock And Calendar Function".
- If appending time and date to data output, refer to the [Time/Date output (S-t d)] of "10.2.Details Of The Function Table".
- If appending temperature data to the data output, refer to [Temperature output (S-t P)] of "10.2.Details Of The Function Table".

## 6.7. Repeatability Test

The repeatability means the weighing error when measuring the same mass repeatedly.

The standard deviation is generally used for the indicator of the repeatability.

The repeatability test measures the built-in mass 10 times and displays the standard deviation.

Use the repeatability test to inspect the performance of the balance when changing environment or when moving the balance to a new location.

Example: "The standard deviation = 0.2 mg" means that the probability of weighing error within  $\pm 0.2$  mg is approx. 68% when measuring the same mass repeatedly.

### Note

- The repeatability test uses the internal mass. Therefore, the standard deviation discords to item repeatability of "17.Specifications". Regard the standard deviation as a reference.

| Products                       | Internal mass |
|--------------------------------|---------------|
| BM-20, BM-22                   | Approx. 20 g  |
| BM-252, BM-500, BM-300, BM-200 | Approx. 190 g |

- 1 Press and hold the **RANGE** key, Release the key when displaying **rEP tEST**.
- 2 When displaying **rEP tEST**, the measurement is automatically started, **rEP** blinks and the measurement count (0 to 10) is displayed. When stopping the current measurement, press the **CAL** key.

### Note

- Avoid vibration and breezes for precise measurement during this test.
- 3 At the end of the measurement, the standard deviation of the repeatability is displayed.
  - 4 Press the **CAL** key or **PRINT** key to return to weighing mode.

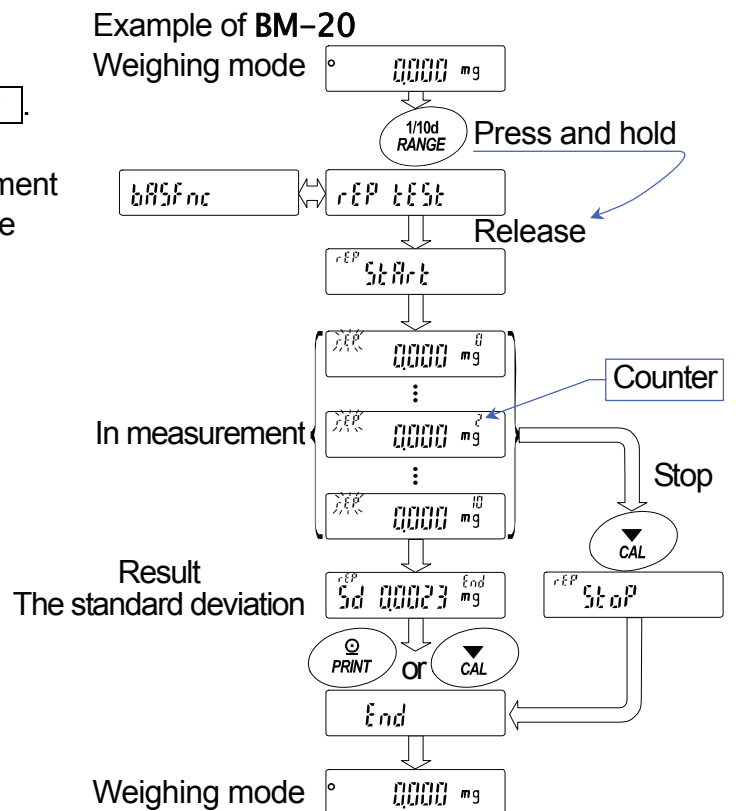

## 7. Response Adjustment

This function stabilizes the weight value by reducing the influence on weighing that is caused by drafts and/or vibration at the place where the balance is installed. The adjustment of the function can be performed by analyzing the environment automatically or hand-operation. The state of the function has three stages as follows :

| Indicator | Parameter | Response       | Stability       |
|-----------|-----------|----------------|-----------------|
| FAST      | [End 0]   | Fast response, | Sensitive value |
| MID.      | [End 1]   | ↑              | ↓               |
| SLOW      | [End 2]   | Slow response, | Stable value    |

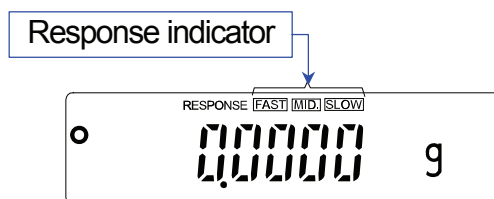

### 7.1. Automatic Response Adjustment

This function automatically updates the response adjustment by analyzing the influence of the environment using the internal mass.

- 1 Press and hold the [MODE] key until [RESPONSE] is displayed, then release the key.
- 2 The balance automatically sets the response characteristic.

**Caution Do not allow vibration or drafts to affect the balance during adjustment.**

- 3 After automatic adjustment, the balance displays [End], returns to the weighing mode and displays the updated response indicator for about thirty seconds.

#### Note

- If the automatic response adjustment fails, the balance displays [EH nG]. Check the ambient conditions such as breeze and vibration, also check the weighing pan. Then, perform the adjustment again. Press the [CAL] key to return to the weighing mode.
- If there is anything on the weighing pan, the balance displays [EH 0]. Remove the substance from the pan. Press the [CAL] key to return to the weighing mode.

#### Advise

If the automatic response adjustment is not helpful, try "7.2. Manual Response Adjustment".

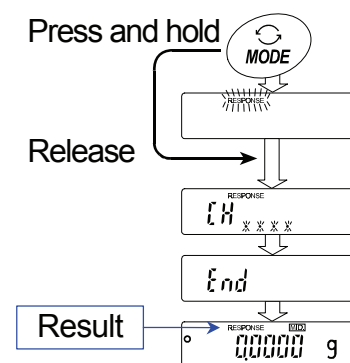

## 7.2. Manual Response Adjustment

- 1 Press and hold the **MODE** key until **RESPONSE** is displayed, then release the key.  
Press the **MODE** key again quickly.
- 2 Select a setting for the response adjustment using the **MODE** key. Either **FAST**, **MID.** or **SLOW** can be selected.
- 3 The balance displays **End**, returns to the weighing mode and displays the updated response indicator for about thirty seconds.

### Advise

If the automatic response adjustment is not helpful, specify a parameter for "Condition (*End*)" of "Environment, Display (*bRSFnc*)" with key operation.

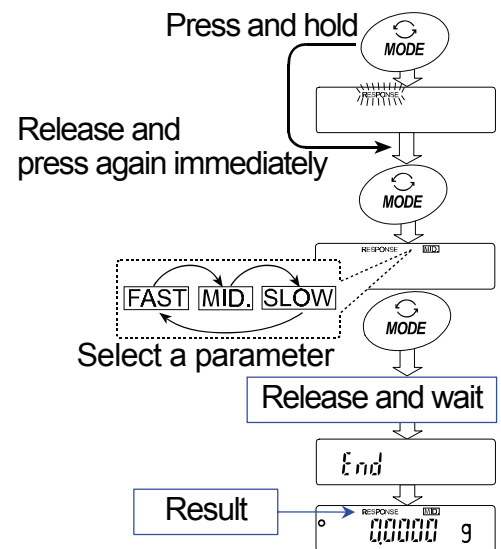



## 8. Calibration (To Adjust The Weighing Value)

### 8.1. Calibration Group

#### Calibration

Automatic self calibration (Calibration due to changes in temperature)

Calibration using the internal mass (One-touch calibration)

Calibration using an external weight that you have

#### Calibration test

Calibration test using the internal mass

Calibration test using target mass that you have

#### Correction of the internal mass value

Correction of the internal mass value

#### Caution

- Do not allow vibration or drafts to affect the balance during calibration.
- Calibration test does not perform calibration.
- When using the data output for GLP using the RS-232C interface, set "GLP output ( *INF0* )" of the function table. Refer to "10. Function Table". Time and date can be added to the GLP report. If it is incorrect, refer to "10.7 Clock and Calendar Function" and adjust them.
- Calibration test is available only when "GLP output ( *INF0* )" is set .
- The calibration and calibration test data can be stored in memory. When using memory, set "Data memory ( *DATA* )" of the function table. Refer to "12. Data Memory" for details.

#### Caution on using an external weight

- The accuracy of an external weight can influence the accuracy of weighing.
- Select a mass for calibration and calibration test from the following table.

| Model  | Usable calibration mass |       |               |       |               | Adjustable range       |
|--------|-------------------------|-------|---------------|-------|---------------|------------------------|
| BM-20  | 1 g                     | 2 g   | 5 g           | 10 g  | <b>20 g*</b>  | -3.000 mg to +3.099 mg |
| BM-22  | 1 g                     | 2 g   | 5 g           | 10 g  | <b>20 g*</b>  |                        |
| BM-252 | 10 g                    | 20 g  | 50 g          | 100 g | <b>200 g*</b> | -15.00 mg to +15.99 mg |
| BM-200 | 50 g                    | 100 g | <b>200 g*</b> |       |               | -30.0 mg to +30.9 mg   |
| BM-300 | 50 g                    | 100 g | <b>200 g*</b> | 300 g |               |                        |
| BM-500 | 50 g                    | 100 g | <b>200 g*</b> | 300 g | 500 g         |                        |

**Bold type\*:** Factory setting.

The calibration mass value can be adjusted within the range above.

#### About the internal mass

- The internal mass may change due to corrosion or other damage caused by the operating environment, or due to aging. Check the internal mass periodically and correct the internal mass value if necessary. Refer to "8.7. Correcting the Internal Mass Value".

#### Display



This indicator means "In process of measuring calibration data".

Do not allow vibration or drafts to affect the balance while the indicator is displayed.

## 8.2. Automatic Self Calibration (For variation of ambient temperature)

### Automatic self calibration due to changes in temperature

This function automatically calibrates the balance when the balance detects an ambient temperature change. If GLP output is selected in the function table, the balance outputs the calibration report or stores the data in memory. Automatic self calibration functions even if the display is turned off (standby state). Refer to "9.1. Permit Or Inhibit" for the operation.

#### Caution

- Place nothing on the weighing pan during automatic self calibration.
- If something is on the weighing pan, the balance decides that it is in use and does not perform automatic self calibration.
- When weighing a light sample, using a long term weighing or installing the balance in a system, turn off automatic self calibration.

**Note** When turning on the balance with nothing on the pan, if a sample heavier than 0.5 g is placed on the pan, the balance detects the state that a sample is placed on the pan and does not perform the automatic self calibration.



The mark ◀ is "prior notice indicator of automatic self calibration".

When the balance detects a change in ambient temperature, this indicator blinks and automatic self calibration is required. If the balance is not used for several minutes with this indicator blinking, the balance performs automatic self calibration. The environment will affect the time that the indicator blinks.

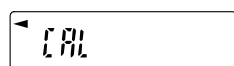

The balance is measuring calibration data. Do not allow vibration or drafts to affect the balance while this indicator is displayed. After calibration, the balance returns to indicate the previous display.

#### Advise

The balance can be used while the indicator blinks. But, it is recommended that to maintain the accuracy, stop using the balance and confirm that there is nothing on the pan and allow the balance to perform self calibration.

## 8.3. One-Touch Calibration (For Common Use)

- This function calibrates the balance using the internal mass.
  - The only operation required is to press the **CAL** key.
- 1 Connect the AC adapter and warm up the balance for at least one hour with nothing on the weighing pan.
  - 2 Press the **CAL** key to display **CAL in**.
  - 3 The balance performs calibration using the internal mass. Do not allow vibration or drafts to affect the balance.
  - 4 If GLP output is set, **GLP** is displayed, the calibration test report is output to the RS-232C interface and is stored in memory. Refer to "GLP output (info)" and "Data memory (data)" of the function table, "11.2. GLP Report" and "12. Data Memory". **End** is displayed after the calibration.
  - 5 The balance will automatically return to the weighing mode after calibration.
  - 6 Confirm weighing accuracy using calibration test (**CC in**).

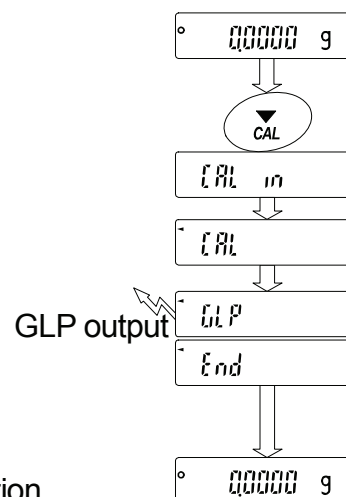

## 8.4. Calibration Test Using the Internal Mass

- This function tests the balance accuracy using the internal mass.
- Calibration test does not perform calibration.
- When GLP output is set, the calibration test report is output or stored.

1 Connect the AC adapter and warm up the balance at least one hour.

2 Press and hold the **CAL** key until **[[ in** is displayed, then release the key.

3 The balance measures the zero point.  
Prevent vibration and drafts to affect the balance.

4 The measured zero point data is displayed.

5 The balance measures the internal mass.  
Prevent vibration and drafts to affect the balance.

6 The value of the internal mass is displayed.  
The normal range of the value is as follows:

| Model                                    | The internal mass | The normal range |
|--|-------------------|------------------|
| <b>BM-20, BM-22</b>                      | 20.00000 g        | ±0.02 mg         |
| <b>BM-252, BM-200<br/>BM-300, BM-500</b> | 200.0000 g        | ±0.2 mg          |

7 If GLP output is set, **GLP** is displayed, the calibration test report is output to the RS-232C interface and is stored in memory. Refer to "GLP output (info)" and "Data memory (data)" of the function table, "11.2. GLP Report" and "12. Data Memory".

**End** is displayed after the calibration.

9 The balance automatically returns to the weighing mode.

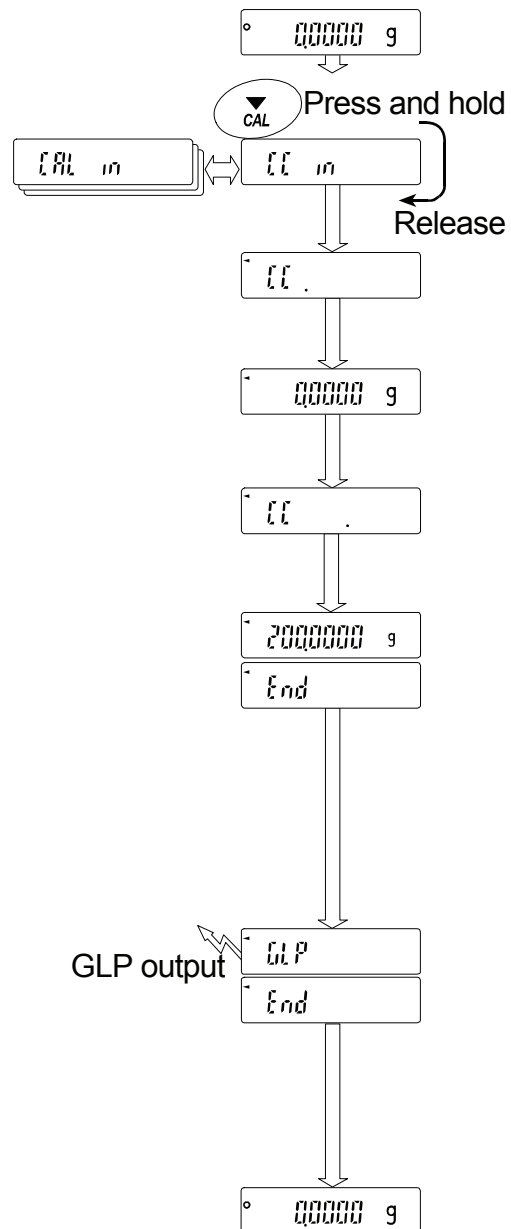

## 8.5. Calibration Using An External Weight

- This function calibrates the balance using an external weight.

- 1 Connect the AC adapter and warm up the balance for at least one hour with nothing on the weighing pan.
- 2 Press and hold the **CAL** key until **CALout** is displayed, then release the key.
- 3 When displaying **CAL 0**, proceed as follows:
  - If you want to change the calibration mass, press the **RANGE** key and proceed to step 4.
  - If you use the calibration mass value stored in the balance, proceed to step 5.
- 4 Specify the calibration mass value as follows:
  - RANGE** key ..... The key to switch blinking figures.
  - RE-ZERO**(+)key..... The keys to select the calibration mass or adjust the mass value. Refer to page 31.
  - MODE**(-)key ..... adjust the mass value. Refer to page 31.
  - PRINT** key..... The key to store the new mass value. Even if the AC adapter is removed, the data is maintained in non-volatile memory.
  - CAL** key ..... The key to cancel the operation and return to **CAL 0**.
- 5 Confirm that there is nothing on the pan and press the **PRINT** key. The balance measures the zero point. Do not allow vibration or drafts to affect the balance. The balance displays the calibration mass value.
- 6 Place the displayed calibration weight on the pan and press the **PRINT** key. The balance measures the calibration mass. Do not allow vibration or drafts to affect the balance.
- 7 **End** is displayed. Remove the weight from the pan.
- 8 If GLP output is set, **GLP** is displayed and the calibration report is output and stored. Refer to "GLP output (info)" and "Data memory (data)" of the function table, "11.2. GLP Report" and "12. Data Memory".
- 9 The balance will automatically return to the weighing mode.
- 10 Place the calibration weight on the pan and confirm that the value displayed is correct. If it is not within the range, check the ambient conditions such as breeze and vibration also check the weighing pan. Then, repeat steps 1 to 10.

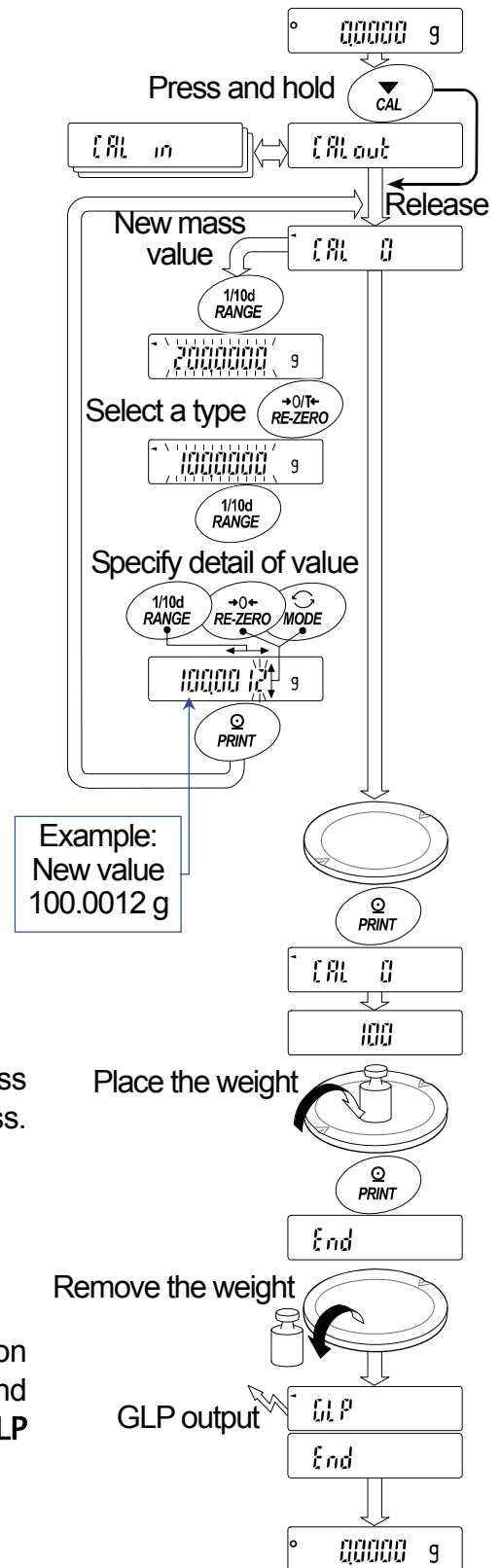

## 8.6. Calibration Test Using An External Weight

- This function tests the weighing accuracy using an external weight.
- Calibration test report can be output or stored with "GLP output ( *inf*o)"
- Calibration test does not perform calibration.

- 1 Connect the AC adapter and warm up the balance for at least one hour with nothing on the weighing pan.
- 2 Press and hold the **CAL** key until **[[ out** is displayed, then release the key.
- 3 When displaying **[[ 0**, proceed as follows:
  - If the target mass is changed, press the **RANGE** key and proceed to step 4. A list of usable weights is on page 31.
  - If current target mass value is used, proceed to step 5.
- 4 Specify the target mass value as follows:
  - RANGE** key ..... The key to switch blinking figures.
  - RE-ZERO**(+)key ... The keys to select the target mass or
  - MODE**(-)key ..... adjust the mass value. Refer to page 31.
  - PRINT** key ..... The key to store the new mass value.

Even if the AC adapter is removed, the data is maintained in non-volatile memory.

  - CAL** key ..... The key to cancel the operation and return to **[[ 0**.
- 5 Confirm that there is nothing on the pan and press the **PRINT** key. The balance measures the zero point and displays the measured value. Do not allow vibration or drafts to affect the balance. The balance displays the target mass value.
- 6 Place the displayed target mass on the pan and press the **PRINT** key. The balance measures the target mass and displays the measured value. Do not allow vibration or drafts to affect the balance.
- 7 **End** is displayed.  
Remove the weight from the pan.
- 8 If GLP output is set, **GLP** is displayed and the calibration report is output and stored. Refer to "GLP output ( *inf*o)" and "Data memory ( *data*)" of the function table, "11.2. GLP Report" and "12. Data Memory".
- 9 The balance will automatically return to the weighing mode.

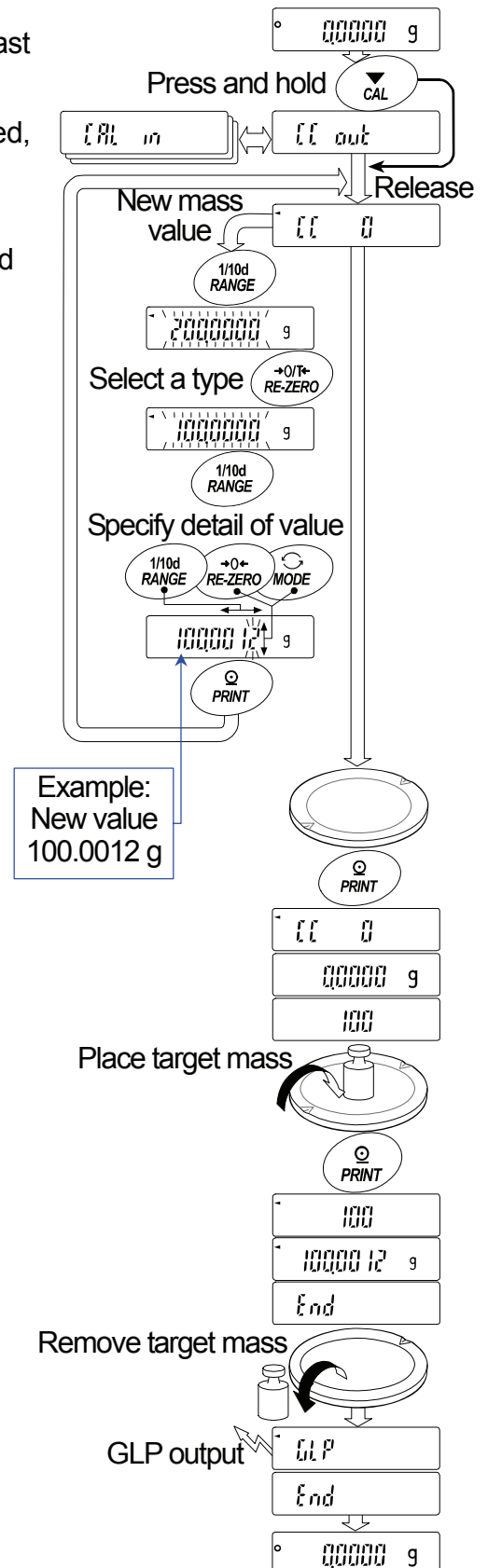

## 8.7. Correcting The Internal Mass Value

- The balance can correct the internal mass value within the range shown below. This function corrects the internal mass value to conform to an external weight. The corrected mass value is maintained in non-volatile memory even if the AC adapter is removed. The internal mass value is corrected as follows:

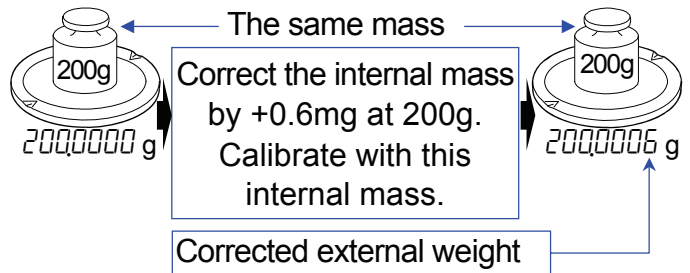

| Model                          | The internal mass | The normal range |
|--------------------------------|-------------------|------------------|
| BM-20, BM-22                   | 20.00000 g        | ±0.15 mg         |
| BM-252, BM-200, BM-300, BM-500 | 200.0000 g        | ±1.5 mg          |

**Example:** 200.0000 g is corrected to +0.6 mg (200.0006 g). When using a 100 g external weight by +0.6 mg for the correction, and the weight changed to 200 g, the correction value is +1.2 mg.

- Perform one-touch calibration. Weigh an external weight and get the correction value.
- Press the **ON:OFF** key to turn off the display.
- While pressing and holding the **PRINT** key and the **RANGE** key, press the **ON:OFF** key. **PS** is displayed.
- Press the **PRINT** key to display the function switches. Set the function table switch and internal mass correction switch to "I" as shown above using the following keys.
  - RANGE** key.....The key to select blinking figure.
  - RE-ZERO** key....The key to change the value of the blinking figure.
  - PRINT** key.....The key to store it and return to weighing mode.
  - CAL** key.....The key to cancel current operation.

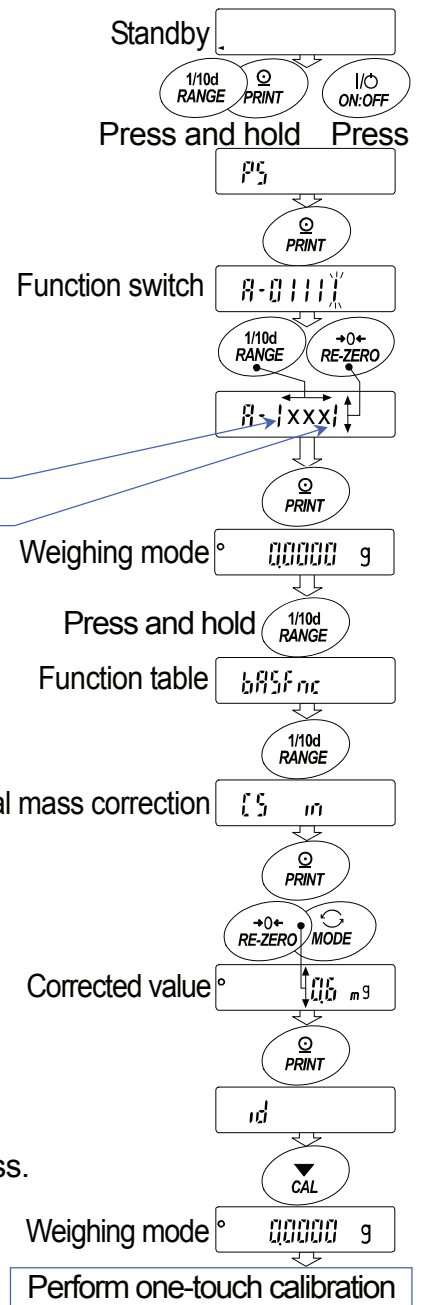

- Press and hold the **RANGE** key to enter the function table and release the key when **bR5FnC** is displayed.
- Press the **RANGE** key several times until **0.5 in** is displayed, then release the key.
- Press the **PRINT** key. Correct the internal mass value using the following keys.
  - RE-ZERO(+)**key ....The key to increase the value.
  - MODE(-)**key .....The key to decrease the value.
  - PRINT** key.....The key to store the new value and display the next menu item of the function table.
  - CAL** key.....The key to cancel this correction and display the next menu item of the function table.
- Press the **CAL** key to return the weighing mode.
- Press the **CAL** key to calibrate the balance using the internal mass.
- Check that the correction has been performed properly with the external weight. If the value is incorrect, repeat the correction.

# 9. Function Switch And Initialization

## 9.1. Permit Or Inhibit

- The balance stores parameters that must not be changed unintentionally.  
Example: Calibration data for accurate weighing, Data for adapting to the operating environment, Control data for the RS-232C interface.
- The balance is equipped with five switches for the purpose of protecting parameters. Each switch can select either "permit" or "inhibit". "Inhibit" protects parameters against unintentional operations.

- 1 Press the **ON:OFF** key to turn off the display.
- 2 While pressing and holding the **PRINT** key and the **RANGE** key, press the **ON:OFF** key to display **P5**.
- 3 Press the **PRINT** key. Then the balance displays the function switches.
- 4 Specify the switches using the following keys.

**RANGE** key..... The key to select blinking digit.

**RE-ZERO** key..... The key to change the parameter for the selected switch.  
□ To inhibit changes. (Can not be used.)  
/ To permit changes. (Can be used.)

**PRINT** key ..... The key to store the new parameter and return to the weighing mode.

**CAL** key..... The key to cancel current operation and return to the weighing mode.

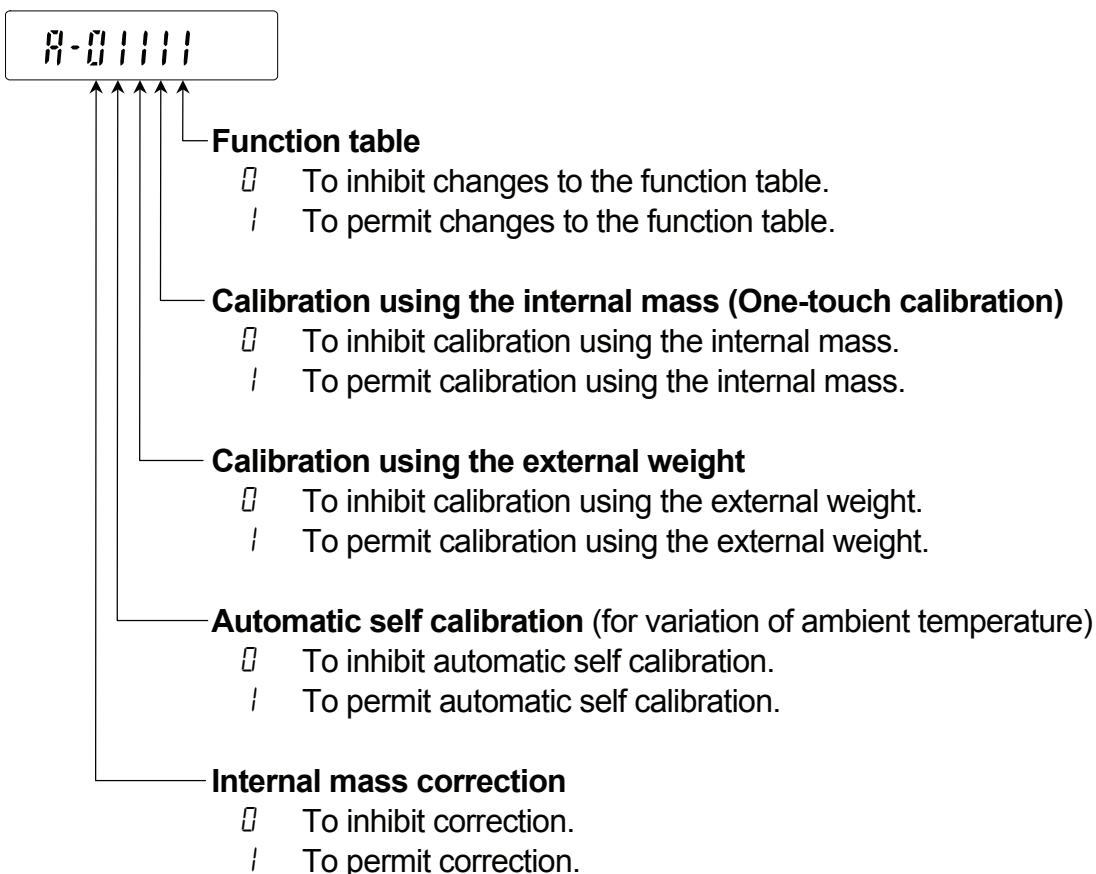

## 9.2. Initializing The Balance

- This function returns the following parameters to factory settings.
  - Calibration data
  - Function table
  - The sample unit mass value (counting mode),  
100% reference mass value (percent mode)
  - The data that is stored in the balance using the data memory function
  - External calibration weight and target mass value
  - Function switch settings ("9.1. Permit Or Inhibit")
  - Liquid density and temperature in the density mode

**Note** Be sure to calibrate the balance after initialization.

- 1 Press the **ON:OFF** key to turn off the display.
- 2 While pressing and holding the **PRINT** key and the **RANGE** key, press the **ON:OFF** key to display **P5**.
- 3 Press the **RANGE** key to display **CLr**.
- 4 Press the **PRINT** key.  
To cancel this operation, press the **CAL** key.
- 5 Press the **RE-ZERO** key to display **CLr 00**.
- 6 Press the **PRINT** key to initialize the balance.  
The balance will automatically return to the weighing mode.

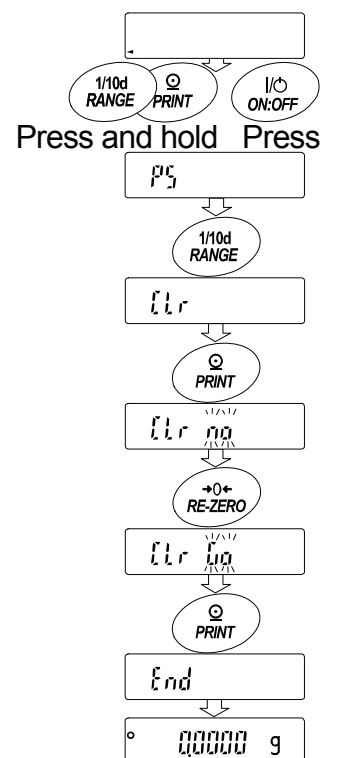







# 10. Function Table

The function table reads or rewrites the parameters that are stored in the balance. These parameters are maintained in non-volatile memory, even if the AC adapter is removed. The function table menu consists of two layers. The first layer is the "Class" and the second layer is the "Item".

## 10.1. Setting The Function Table

### Display symbol and keys

|   |   |
|---|---|
|    | The symbol "o" shows effective parameter.   |
|    | When pressing and holding the key in the weighing mode, the balance enters the function table mode.<br>The key to select the class or item in the function table mode.                      |
|    | The key to change the parameter.  |
|  | When displaying a class, the key enters an item in the class.<br>When displaying an item, the key stores the new parameter and displays the next class.                                     |
|  | When displaying an item, the key cancels the new parameter and displays the next class.<br>When displaying a class, the key exits the function table mode and returns to the weighing mode. |

### Setting Procedure

- 1 Press and hold the **RANGE** key until **bPStFnC** of the function table is displayed in the weighing mode, then release the key
- 2 Press the **RANGE** key to select a class.
- 3 Press the **PRINT** key to enter the class
- 4 Press the **RANGE** key to select a item.
- 5 Press the **RE-ZERO** key to select a parameter for the selected item.
- 6 If storing parameters of the selected class, press the **PRINT** key.  
Then the next class is displayed.  
If canceling the current operation, press the **CAL** key. Then the next class is displayed.
- 7 When specifying parameters for another class, proceed to step 2.  
When finishing the setting, press the **CAL** key to return to weighing mode.

## Setting Example

This example sets "Stores weighing data" for "Data memory" and "1 minute" for "Interval time".

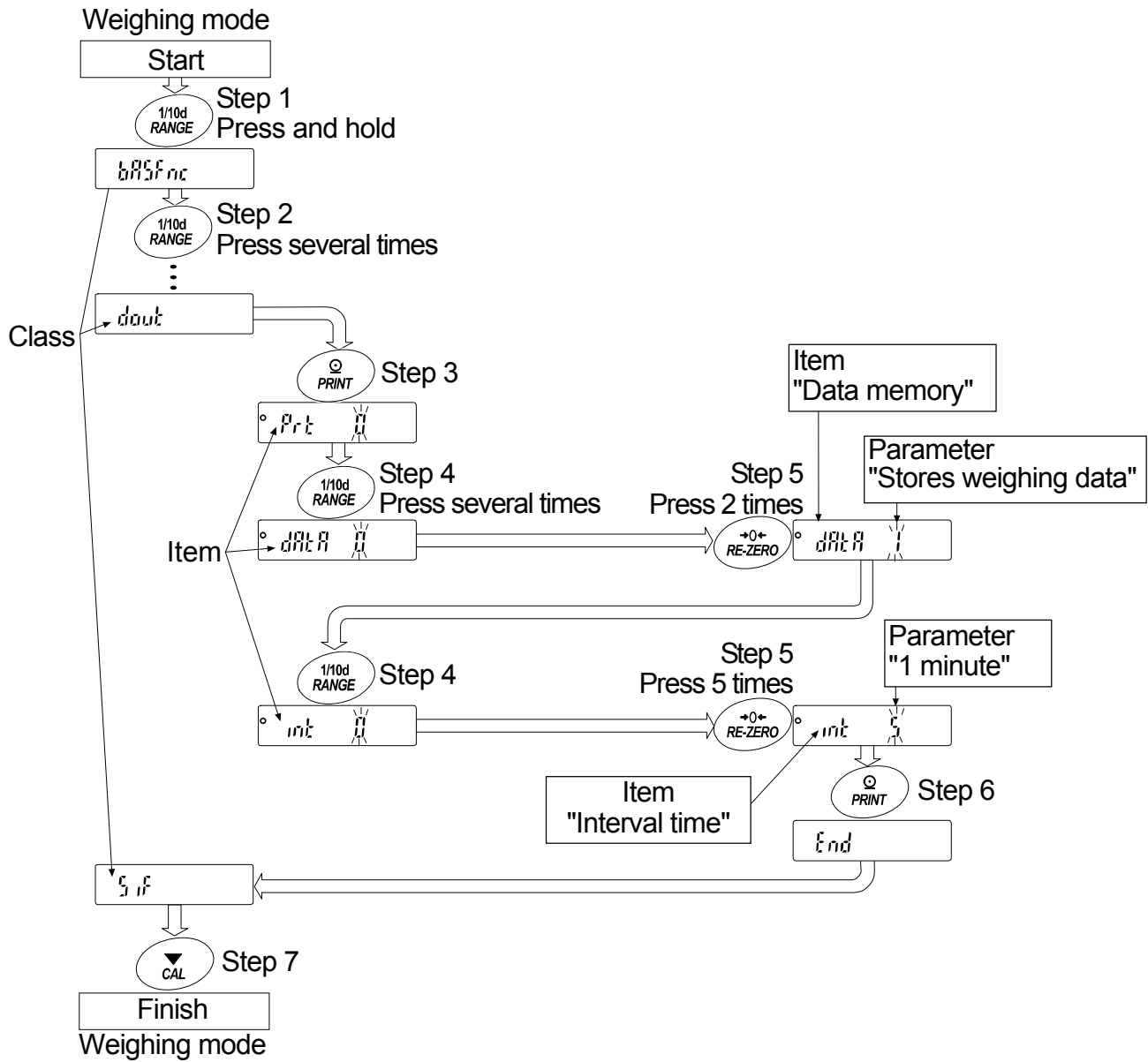

## 10.2. Details Of The Function Table

| Class                            | Item and Parameter                           |                         | Description   |  |
|----------------------------------|--|-------------------------|---|--|
| bRSFnC<br>Environment<br>Display | Cond<br>Condition                            | 0                       | Fast response, sensitive value <span style="border: 1px solid black; padding: 2px;">FAST</span>   |  |
|                                  |  | 1                       | ↕   |  |
|                                  |  | 2                       | Slow response, stable value <span style="border: 1px solid black; padding: 2px;">MID</span><br><span style="border: 1px solid black; padding: 2px;">SLOW</span> |  |
|                                  | St-b<br>Stability band width                 | 0                       | Stable range is ±1 digit  | The stabilization indicator illuminates when the display fluctuation is within the range.                          |
|                                  |  | 1                       | ↕   |  |
|                                  |  | 2                       | Stable range is ±2 digit #1<br>Stable range is ±3 digits  |  |
|                                  | PLoc<br>Display lock function                | OFF                     | OFF   | Display hold function to measure the volume dispensed from the pipette.  |
|                                  |  | ON                      | ON  |  |
| trc<br>Zero tracking             | 0  | OFF                     | Keeps zero display by tracking zero drift.  |  |
|                                  | 1  | Normal                  |   |  |
|                                  | 2  | Strong                  |   |  |
| SPd<br>Display refresh rate      | 0  | 5 times/second          | Period to refresh the display   |  |
|                                  | 1  | 10 times/second         |   |  |
|                                  | 2  | Very strong             |   |  |
| Pnt<br>Decimal point             | 0  | Point (.)               | Decimal point format  |  |
|                                  | 1  | Comma (,)               |   |  |
| P-on<br>Auto display-ON          | OFF  | OFF                     | Turns on the weighing mode display when the AC adapter is connected.  |  |
|                                  | ON   | ON                      |   |  |
| bEEP<br>Beep                     | OFF  | OFF                     | Turns on the weighing mode display when the AC adapter is connected.  |  |
|                                  | ON   | ON                      |   |  |
| CL Add<br>Clock                  | Refer to "10.7. Clock and Calendar Function" |                         | The time and date are added to the output data.   |  |
| dout<br>Data output              | Prt<br>Data output mode                      | 0                       | Key mode  | Accepts the <span style="border: 1px solid black; padding: 2px;">PRINT</span> key only when the display is stable. |
|                                  |  | 1                       | Auto print mode A<br>Reference = zero   | Outputs data when the display is stable and conditions of AP-P, AP-b and the reference value are met.              |
|                                  |  | 2                       | Auto print mode B<br>Reference = last stable value  |  |
|                                  | AP-P<br>Auto print polarity                  | 0                       | Plus only   | Displayed value > Reference  |
|                                  |  | 1                       | Minus only  | Displayed value < Reference  |
|                                  |  | 2                       | Both  | Regardless of displayed value  |
|                                  | AP-b<br>Auto print difference                | 0                       | 10 digits   | Difference between reference value and displayed value #2  |
| 1                                |  | 100 digits              |   |  |
| 2                                |  | 1000 digits             |   |  |
| dAtA<br>Data memory              | 0  | Not used                | Related items:<br>Prt, int, d-no, S-td, info  |  |
|                                  | 1  | Stores weighing data    |   |  |
|                                  | 2  | Stores calibration data |   |  |

▪ : Factory settings.

#1 The unit of minimum display is digit.

Example: If 1 mg display is selected using the RANGE key for the **BM-300**, 1 mg is one digit.

#2 Usable minimum display of the balance is one digit.

Example: In gram display, one digit is 0.01 mg for the **BM-252** and 0.1 mg for the **BM-300**.

| Class                      | Item and Parameter           | Description         |   |  |
|----------------------------|------------------------------|---------------------|---|--|
| dout<br>Data output        | int<br>Interval time         | 0                   | Every measurement   | Interval time in the interval memory mode when using <i>Prt</i> 3, <i>dRtR</i> 1 |
|                            |                              | 1                   | 2 seconds   |  |
|                            |                              | 2                   | 5 seconds   |  |
|                            |                              | 3                   | 10 seconds  |  |
|                            |                              | 4                   | 30 seconds  |  |
|                            |                              | 5                   | 1 minutes   |  |
|                            |                              | 6                   | 2 minutes   |  |
|                            |                              | 7                   | 5 minutes   |  |
|                            |                              | 8                   | 10 minutes  |  |
|                            | d-no<br>Data number output   | off                 | No output   | Refer to "12. Data Memory"   |
| on                         | Output                       |                     |   |  |
| 5-td<br>Time/Date output   | 0                            | No output           | Selects whether or not the time or date is added to the weighting data. Refer to "10.7. Clock and Calendar Function" for details. |  |
|                            | 1                            | Time only           |   |  |
|                            | 2                            | Date only           |   |  |
| 5-id<br>ID number output   | off                          | No output           | Selects whether or not the ID number is output.   |  |
|                            | on                           | Output              |   |  |
| PUSE<br>Data output pause  | off                          | No pause            | Selects the data output interval.   |  |
| on                         | Pause (1.6 seconds)          |                     |   |  |
| Rt-F<br>Auto feed          | off                          | Not used            | Selects whether or not automatic feed is performed.   |  |
| on                         | Used                         |                     |   |  |
| info<br>GLP output         | 0                            | No output           | Selects GLP output method. Refer to "11. ID Number And GLP Report" for details.   |  |
|                            | 1                            | AD-8121 format      |   |  |
|                            | 2                            | General data format |   |  |
| Rr-d<br>Zero after output  | off                          | Not used            | Adjusts zero automatically after data is output   |  |
|                            | on                           | Used                |   |  |
| 5-tP<br>Temperature output | off                          | Not output          | Adds temperature to data output   |  |
|                            | on                           | Output              |   |  |
| 5iF<br>Serial interface    | bPS<br>Baud rate             | 0                   | 600 bps   |  |
|                            |                              | 1                   | 1200 bps  |  |
|                            |                              | 2                   | 2400 bps  |  |
|                            |                              | 3                   | 4800 bps  |  |
|                            |                              | 4                   | 9600 bps  |  |
|                            |                              | 5                   | 19200 bps   |  |
|                            | btPr<br>Data bit, parity bit | 0                   | 7 bits, even  |  |
|                            |                              | 1                   | 7 bits, odd   |  |
|                            |                              | 2                   | 8 bits, none  |  |
|                            | CrLF<br>Terminator           | 0                   | CR LF   | CR: ASCII code 0Dh<br>LF: ASCII code 0Ah   |
| 1                          |                              | CR                  |   |  |
| tYPE<br>Data format        | 0                            | A&D standard format | Refer to "10.5. Description of Item "Data Format" ".  |  |
|                            | 1                            | DP format           |   |  |
|                            | 2                            | KF format           |   |  |
|                            | 3                            | MT format           |   |  |
|                            | 4                            | NU format           |   |  |
| 5                          | CSV format                   |                     |   |  |

▪ : Factory settings.

**Caution** The balance may not transmit the data completely at the specified refresh rate, depending on the baud rate or data added to the weighing data such as time, date and ID number.

| Class                                 | Item and Parameter            |                        | Description  |  |   |
|---------------------------------------|-------------------------------|------------------------|--|--|---|
| S <sub>IF</sub><br>Serial interface   | t-UP<br>Timeout               | OFF<br>ON              | No limit<br>1 second   | Selects the wait time to receive a command.      |   |
|                                       | ErCd<br>AK, Error code        | OFF<br>ON              | No output<br>Output  |  | AK: ASCII code 06h  |
| dS <sub>Fnc</sub><br>Density function | Ld in<br>Liquid density input | 0<br>1                 | Water temperature<br>Liquid density  | Available only when density mode is selected     |   |
|                                       | Unit                          |                        |  |  | Refer to "5. Weighing Units".   |
| ES in<br>Internal mass correction     |                               |                        | Displayed only when the internal mass value correction switch is set to 1. Refer to "8. Calibration (To Adjust The Weighing Value)". |  |   |
| id<br>ID number setting               |                               |                        | Refer to "11. ID Number And GLP Report".   |  |   |
| ionFnc<br>Static eliminator           | ion<br>Neutralization time    | 0<br>1<br>2            | 3 seconds<br>10 seconds<br>Manual operation (max. 10 min.)   | Refer to "6.5. Built-in DC Static Eliminator" ". |   |
|                                       |                               | 8922<br>AD8922 control | OFF<br>ON  |  | The [ION] key is not used.<br>Applies the [ION] key to the [MODE] key on AD-8922. |
|                                       |                               |                        | E-5<br>External control input  |  | 0<br>1<br>2   |
|                                       | door<br>Door state function   | d-dt<br>Door sensor    |  | OFF<br>ON  | No used<br>Used   |

▪ : Factory settings.

## 10.3. Description Of The Class "Environment, Display"

### Condition (Cond)

Cond 0  This parameter is for sensitive response to the fluctuation of a mass value. Used for powder target mass, weighing a very light sample or when quick response weighing is required. After setting, the balance displays [FAST].

Cond 2 This parameter is for stable weighing with slow response. Used to prevent a mass value from drifting due to vibration or drafts. After setting, the balance displays [SLOW].

**Notes** In automatic response adjustment, this parameter is selected automatically.

### Stability band width (St-b)

This item controls the width to regard a mass value as a stable value. When the fluctuation per second is less than the parameter, the balance displays the stabilization indicator and outputs or stores the data. The parameter influences the "Auto print mode".

St-b 0  This parameter is used for sensitive response of the stabilization indicator. Used for exact weighing.

St-b 2 This parameter ignores slight fluctuations of a mass value. Used to prevent a mass value from drifting due to vibration or drafts.

## Display Hold Function ( $P_{Loc}$ )

- This function is used to measure the volume dispensed from the pipette.  
When specifying "Display lock function is used" ( $P_{Loc On}$ ) in the function table, dispensing liquid into the weighing bottle from the pipette and getting a stable weighing value, the balance calculates an average value and displays the result (a fixed value).

- When using this function for the measurement of a small volume, the influence of water evaporation can be reduced.

**Caution** Even if using the weighing bottle (evaporator trap) to reduce the water evaporation, at least 0.05 mg (0.05  $\mu\ell$ ) evaporation will occur .

- When canceling this function, press the CAL key.



## Zero tracking ( $t_{rc}$ )

This function tracks zero point drift caused by changes in the environment and stabilizes the zero point. When the weighing data is only a few digits, turn the function off for accurate weighing.

$t_{rc} 0$  The tracking function is not used. Used for weighing a very light sample.

$t_{rc} 1$  The normal tracking function is used.

$t_{rc} 2$  The strong tracking function is used.

$t_{rc} 3$  The very strong tracking function is used. Used for stable zero display.

## Display refresh rate ( $SP_d$ )

The periodic time to refresh the display. This parameter influences "Baud rate", "Data output pause" and the data output rate of "Stream mode".

## Decimal point ( $P_{nt}$ )

The decimal point format can be selected.

## Auto display-ON ( $P_{-on}$ )

When the AC adapter is plugged in, the display is automatically turned on without the ON:OFF key operation, to display the weighing mode. Used when the balance is built into an automated system. One hour warm up is necessary for accurate weighing.

## 10.4. Description Of The Item "Data Output Mode"

The parameter setting of "Data output mode (*Prt*)" applies to the performance when the "Data memory (*dAtA*)" parameter is set to "2" (to store the weighing data) and when the data is transmitted using the RS-232C interface.

### Key mode

When the PRINT key is pressed with the stabilization indicator turned on, the balance outputs or stores the weighing data and the display blinks one time.

Required setting    *dout*    *Prt* 0    Key mode

### Auto print modes A and B

When the displayed value is stable and the conditions of "Auto print polarity", "Auto print difference" and reference value are met, the balance outputs or stores the weighing data.

When the PRINT key is pressed with the stabilization indicator turned on, the balance outputs or stores the data and the display blinks one time.

#### Auto print mode A

Example                      For weighing each time a sample is placed and removed, with "*Ar-d*" set to "1" (to adjust zero after the data is output).

Required setting    *dout*    *Prt* 1    Auto print mode A (reference = zero)  
*dout*    *AP-P*    Auto print polarity  
*dout*    *AP-b*    Auto print difference  
*dout*    *Ar-d* 1    Zero after output

#### Auto print mode B

Example                      For weighing while a sample is added.

Required setting    *dout*    *Prt* 2    Auto print mode B (reference = last stable value)  
*dout*    *AP-P*    Auto print polarity  
*dout*    *AP-b*    Auto print difference

### Stream mode

The balance outputs the weighing data continuously regardless of the display condition. When the display refresh rate is set to 5 times / second (*SPd* 0), the data output rate is also set to the same 5 times / second. The display does not blink in this mode. The interval memory mode is used when the "Data memory (*dAtA*)" parameter is set to "1" (to store the weighing data).

Example                      For monitoring data on a computer.

Required setting    *dout*    *Prt* 3    Stream mode  
*dout*    *dAtA* 0    Data memory function is not used  
*bRSFnc* *SPd*    Display refresh rate  
*SIF*    *bPS*    Baud rate

**Caution**    The balance may not transmit the data completely at the specified refresh rate, depending on the baud rate or time, date and ID number appended to the weighing data.

### Interval mode

The weighing data is periodically stored in memory.

Example                      For periodical weighing without a personal computer command and to output all of the data, to a computer, at one time.

Required setting    *dout*    *Prt* 3    Interval mode  
*dout*    *dAtA* 2    Data memory function is used  
*dout*    *int*    Interval time

## 10.5. Description Of The Item "Data Format"

### A&D standard format

SIF TYPE 0

This format is used when the peripheral equipment can receive the A&D format.

If an AD-8121B is used, set the printer to MODE 1 or 2.

- This format consists of fifteen or sixteen characters excluding the terminator.  
When numerical characters without a decimal point exceed eight characters for the **BM-20**, **BM-22** and **BM-252**, the format becomes sixteen characters.
- A header of two characters indicates the balance condition.
- The polarity sign is placed before the data with the leading zeros. If the data is zero, the plus sign is applied.
- The unit, consisting of three characters, follows the data.

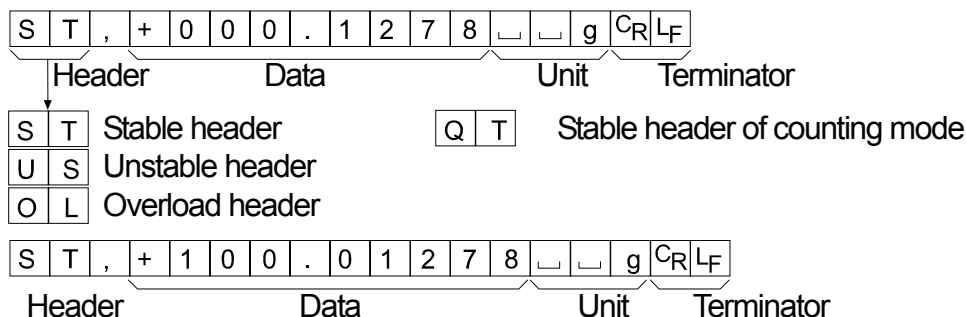

### DP (Dump print) format

SIF TYPE 1

This format is used when the peripheral equipment can not receive the A&D format.

If an AD-8121B is used, set the printer to MODE 3.

- This format consists of sixteen characters excluding the terminator.
- A header of two characters indicates the balance condition. No overload header is used.
  - The polarity sign is placed before the data, with spaces in place of leading zeros, if the data is not zero or overloaded.
- The unit, consisting of three characters, follows the data.

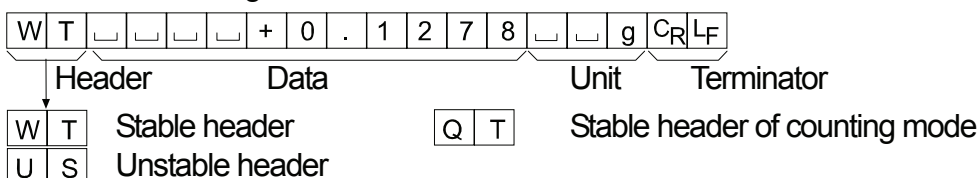

### KF format

SIF TYPE 2

This is the Karl-Fischer moisture meter format and is used when the peripheral equipment can only communicate using this format.

- This format consists of fourteen characters excluding the terminator.
- This format has no header characters.
- The polarity sign is placed before the data, with spaces in place of leading zeros, if the data is not zero or overloaded.
- This format outputs the unit only for a stable value.

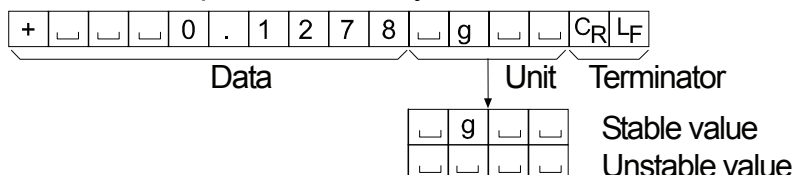



## MT format

SIF TYPE 3

- A header of two characters indicates the balance condition.
- The polarity sign is used only for negative data.
- The weighing data uses spaces in place of the leading zeros.
- The character length of this format changes dependent upon the unit

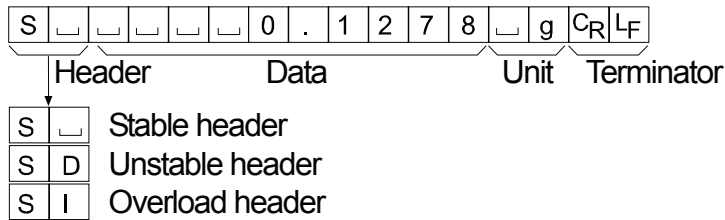

## NU (numerical) format

SIF TYPE 4

This format outputs only numerical data.

- This format consists of ten characters excluding the terminator.
- The polarity sign is placed before the data with the leading zeros. If the data is zero, the plus sign is used.

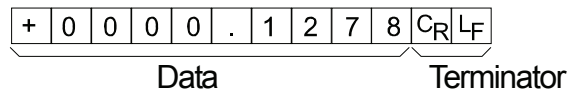

## CSV format

SIF TYPE 5

- This format separates the data of A&D standard format and the unit by a comma ( , ).
- This format outputs the unit even when the data is overloaded.
- When a comma ( , ) is selected for the decimal point, the separators are set to semicolon ( ; ).
- When the ID number, data number, time and date are added at "Data output (*dout*)" of the function table, outputs ID number, data number, date, time and weighing data in this order and separates each item by a comma and treats all the items as one group of data.

LAB-0123, No,012, 2010/11/01, 12:34:56, ST,+0000.1278,  g<CR><LF>

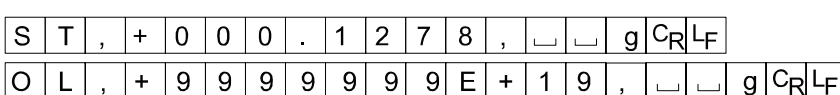

## ID number

dout S- id 1

The number to identify a specific balance.

- This format consists of eight characters excluding the terminator.

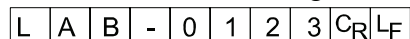

## Data number

dout d-no 1

This format outputs the data number just before the data is transmitted using the RS-232C interface.

- This format consists of six characters excluding the terminator.
- When CSV format (SIF TYPE 5) is selected, the period ( . ) is replaced with a comma ( , ).

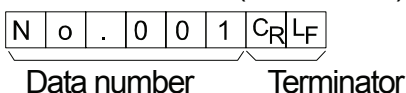

## Date

*dout S-td 2 or 3*

- The date output order can be changed in "Time/Date output (S-td)" and "Clock (CL Add)".  
The year is output in a four-digit format.

|   |   |   |   |   |   |   |   |   |   |                |                |
|---|---|---|---|---|---|---|---|---|---|----------------|----------------|
| 2 | 0 | 1 | 0 | / | 1 | 1 | / | 0 | 1 | C <sub>R</sub> | L <sub>F</sub> |
|---|---|---|---|---|---|---|---|---|---|----------------|----------------|

## Time

*dout S-td 1 or 3*

- This format outputs time in 24-hour format.

|   |   |   |   |   |   |   |   |                |                |
|---|---|---|---|---|---|---|---|----------------|----------------|
| 1 | 2 | : | 3 | 4 | : | 5 | 6 | C <sub>R</sub> | L <sub>F</sub> |
|---|---|---|---|---|---|---|---|----------------|----------------|

## Temperature

*dout S-tP 1*

- This format outputs temperature. The unit is "C".

**Caution** Humidity and air pressure are not output.

|   |   |   |   |   |   |   |   |   |                |                |
|---|---|---|---|---|---|---|---|---|----------------|----------------|
| + | 0 | 2 | 3 | . | 4 | _ | _ | C | C <sub>R</sub> | L <sub>F</sub> |
|---|---|---|---|---|---|---|---|---|----------------|----------------|

## 10.6. Data Format Examples

### Stable

° 0.1278 g

|   |   |   |   |   |   |   |   |   |   |    |    |   |    |    |    |    |    |
|---|---|---|---|---|---|---|---|---|---|----|----|---|----|----|----|----|----|
| S | T | , | + | 0 | 0 | 0 | . | 1 | 2 | 7  | 8  | ␣ | ␣  | g  | CR | LF |    |
| S | T | , | + | 1 | 0 | 0 | . | 0 | 1 | 2  | 7  | 8 | ␣  | ␣  | g  | CR | LF |
| W | T | ␣ | ␣ | ␣ | ␣ | + | 0 | . | 1 | 2  | 7  | 8 | ␣  | ␣  | g  | CR | LF |
| + | ␣ | ␣ | ␣ | 0 | . | 1 | 2 | 7 | 8 | ␣  | g  | ␣ | ␣  | CR | LF |    |    |
| S | ␣ | ␣ | ␣ | ␣ | 0 | . | 1 | 2 | 7 | 8  | ␣  | g | CR | LF |    |    |    |
| + | 0 | 0 | 0 | 0 | . | 1 | 2 | 7 | 8 | CR | LF |   |    |    |    |    |    |

### Unstable

- 10.3690 g

|   |   |   |   |   |   |   |   |   |   |    |    |   |   |    |    |    |    |
|---|---|---|---|---|---|---|---|---|---|----|----|---|---|----|----|----|----|
| U | S | , | - | 0 | 1 | 8 | . | 3 | 6 | 9  | 0  | ␣ | ␣ | g  | CR | LF |    |
| U | S | , | - | 1 | 0 | 1 | . | 8 | 3 | 6  | 9  | 0 | ␣ | ␣  | g  | CR | LF |
| U | S | ␣ | ␣ | ␣ | - | 1 | 8 | . | 3 | 6  | 9  | 0 | ␣ | ␣  | g  | CR | LF |
| - | ␣ | ␣ | 1 | 8 | . | 3 | 6 | 9 | 0 | ␣  | ␣  | ␣ | ␣ | CR | LF |    |    |
| S | D | ␣ | ␣ | - | 1 | 8 | . | 3 | 6 | 9  | 0  | ␣ | g | CR | LF |    |    |
| - | 0 | 0 | 1 | 8 | . | 3 | 6 | 9 | 0 | CR | LF |   |   |    |    |    |    |

### Overload

Positive error

⌘ g

|   |   |   |    |    |   |   |   |   |   |    |    |   |   |    |    |    |  |
|---|---|---|----|----|---|---|---|---|---|----|----|---|---|----|----|----|--|
| O | L | , | +  | 9  | 9 | 9 | 9 | 9 | 9 | E  | +  | 1 | 9 | CR | LF |    |  |
| ␣ | ␣ | ␣ | ␣  | ␣  | ␣ | ␣ | ␣ | E | ␣ | ␣  | ␣  | ␣ | ␣ | ␣  | CR | LF |  |
| ␣ | ␣ | ␣ | ␣  | ␣  | ␣ | H | ␣ | ␣ | ␣ | ␣  | ␣  | ␣ | ␣ | CR | LF |    |  |
| S | I | + | CR | LF |   |   |   |   |   |    |    |   |   |    |    |    |  |
| + | 9 | 9 | 9  | 9  | 9 | 9 | 9 | 9 | 9 | CR | LF |   |   |    |    |    |  |

### Overload

Negative error

-⌘ g

|   |   |   |    |    |   |   |   |   |   |    |    |   |   |    |    |    |  |
|---|---|---|----|----|---|---|---|---|---|----|----|---|---|----|----|----|--|
| O | L | , | -  | 9  | 9 | 9 | 9 | 9 | 9 | E  | +  | 1 | 9 | CR | LF |    |  |
| ␣ | ␣ | ␣ | ␣  | ␣  | ␣ | ␣ | - | E | ␣ | ␣  | ␣  | ␣ | ␣ | ␣  | CR | LF |  |
| ␣ | ␣ | ␣ | ␣  | ␣  | ␣ | L | ␣ | ␣ | ␣ | ␣  | ␣  | ␣ | ␣ | CR | LF |    |  |
| S | I | - | CR | LF |   |   |   |   |   |    |    |   |   |    |    |    |  |
| - | 9 | 9 | 9  | 9  | 9 | 9 | 9 | 9 | 9 | CR | LF |   |   |    |    |    |  |

␣ Space, ASCII 20h  
 CR Carriage Return, ASCII 0Dh  
 LF Line Feed, ASCII 0Ah

# Units

|                              |     | A&D  | D.P. | KF     | MT     |
|------------------------------|-----|------|------|--------|--------|
| g                            | g   | □□g  | □□g  | □g□□   | □g     |
| mg                           | mg  | □mg  | □mg  | □mg□   | □mg    |
| Counting mode                | PC  | □PC  | □PC  | □p c s | □P C S |
| Percent mode                 | %   | □□%  | □□%  | □%□□   | □%     |
| Ounce (Avoir)                | oz  | □oz  | □oz  | □oz□   | □oz    |
| Troy Ounce                   | ozt | □ozt | □ozt | □ozt   | □ozt   |
| Metric Carat                 | ct  | □ct  | □ct  | □ct□   | □ct    |
| Momme                        | mom | □mom | □mom | □mom   | □mo    |
| Pennyweight                  | dwt | □dwt | □dwt | □dwt   | □dwt   |
| Grain                        | GN  | □GN  | □GN  | □gr□   | □GN    |
| Tael (HK general, Singapore) | tl  | □tl  | □tl  | □t l s | □tl    |
| Tael (HK, jewelry)           | tl  | □tl  | □tl  | □t l h | □tl    |
| Tael (Taiwan)                | tl  | □tl  | □tl  | □t l t | □tl    |
| Tael (China)                 | tl  | □tl  | □tl  | □t l c | □tl    |
| Tola (India)                 | t   | □□t  | □□t  | □t o l | □t     |
| Messghal                     | m   | □mes | □mes | □M S □ | □m     |
| Density                      | DS  | □DS  | □DS  | □D S □ | □DS    |

□ Space, ASCII 20h

## 10.7. Clock And Calendar Function

The balance is equipped with a clock and calendar function. When the "GLP output ( *inf* )" and "Time/Date output ( *5-t* )" is used, the time and date can be added to the output data. The operation is as follows:

### Operation

- 1 Press and hold the **RANGE** key until **bASFnC** of the function table is displayed in the weighing mode, then release the key.
- 2 Press the **RANGE** key several times to display **CL Adj**.
- 3 Press the **PRINT** key to enter the mode for the time and date.

### Checking the current time

- 4 The current time is displayed with all the digits blinking.
  - When changing the time, press the **RE-ZERO** key and proceed to step 5.
  - When the time is correct, press the **RANGE** key and proceed to step 6.
  - When exiting the mode, press the **CAL** key and proceed to step 8.

### Storing a new time

- 5 Set the time in 24-hour format using the following keys.
  - RE-ZERO**(+)key · To increase the value by one.
  - MODE**(-)key ····· To decrease the value by one.
  - RANGE** key ····· To select the digits to change the value.
  - PRINT** key ····· To store the new time, and proceed to step 6.
  - CAL** key ····· To cancel operation and proceed to step 6.

### Checking the current date

- 6 The current date is displayed with all the digits blinking.
  - To change the display order of year ( *y* ), month ( *m* ) and day ( *d* ), press the **MODE** key. The date is output in the order as specified.
  - When the date is correct, press the **CAL** key and proceed to step 8.
  - When changing the time again, press the **RANGE** key and proceed back to step 4.
  - When changing the date, press the **RE-ZERO** key and proceed to step 7.

### Storing a new date

- 7 Set the date using the following keys.
  - RE-ZERO**(+)key To increase the value by one.
  - MODE**(-)key ····· To decrease the value by one.
  - RANGE** key ····· To select the digits to change the value.
  - PRINT** key ····· To store the new setting, proceed to step 8.
  - CAL** key ····· To cancel the new setting and proceed to step 8.

### Quitting the operation

- 8 The balance displays the next menu item of the function table. Press the **CAL** key to exit the mode and return to the weighing mode.

**Note** Do not enter invalid values such as a non-existing time and date in this function. When the clock backup battery has been depleted, the balance displays **rbc PF**. Under this condition, press any key and set the time and date. The dead battery only affects the clock and calendar function. Even so, the function works normally as long as the AC adapter is connected to the balance.

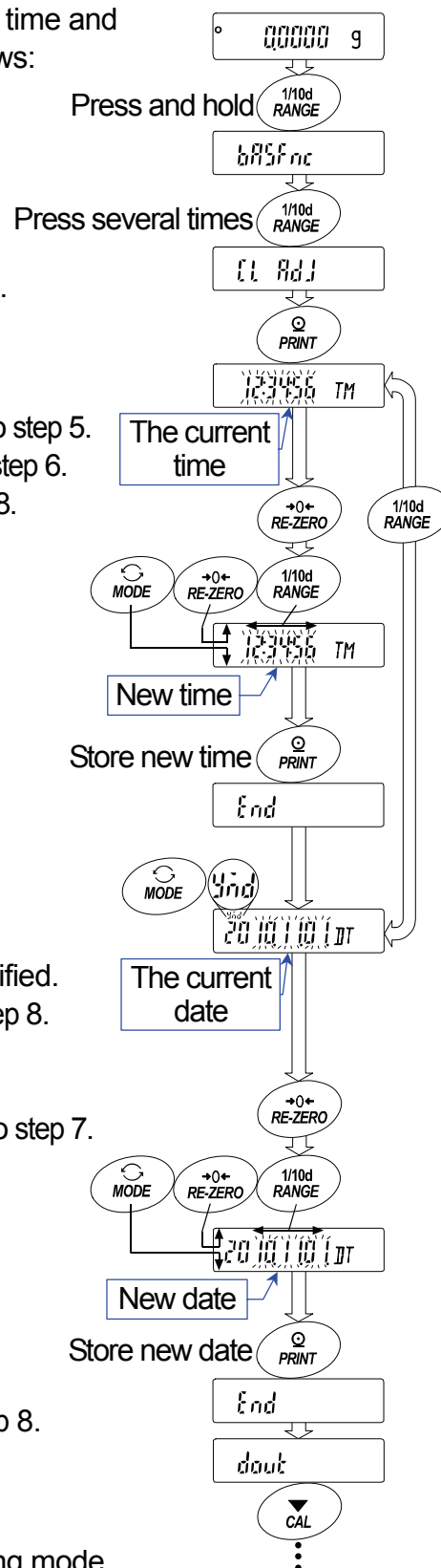

# 11. ID Number And GLP Report

- The ID number is used to identify the balance when Good Laboratory Practice (GLP) is used. The GLP output format is selected at "GLP output ( *info* )" of the function table and can be output to a personal computer or printer using the RS-232C serial interface.
- The GLP output format includes the balance manufacturer, model, serial number, ID number, date, time and space for signature.
- The balance can output the following reports for GLP using the RS-232C serial interface.
  - "Calibration report" of the "Automatic self calibration" and "One-touch calibration" using the internal mass.
  - "Calibration report" of the calibration using an external weight.
  - "Calibration test report" of the calibration test using an external weight.
  - "Title block" and "End block" for the weighing data.
- Calibration and calibration test data can be stored in memory and several reports can be output at the same time. Refer to "12. Data Memory" for details.
- The ID number is maintained in non-volatile memory even if the AC adapter is removed.
- Refer to "10.7. Clock and Calendar Function" for checking and storing the time and date.

## 11.1. Setting The ID Number

- 1 Press and hold the **RANGE** key until **bRSFnc** of the function table is displayed, then release the key.
- 2 Press the **RANGE** key several times to display **id**.
- 3 Press the **PRINT** key. Set the ID number using the following keys.
  - RE-ZERO** key.....The key to set the character of the digit selected.  
Refer to the display character set shown below.
  - RANGE** key.....The key to select the digit to change the character.
  - PRINT** key.....The key to store the new ID number and display **bRSFnc**.
  - CAL** key.....The key to cancel the new ID number and display **bRSFnc**.
- 4 When displaying **bRSFnc**, press the **CAL** key to return to the weighing mode.

|   |   |   |   |   |   |   |   |   |   |   |   |   |   |   |   |   |   |   |   |   |   |   |   |   |   |   |   |   |   |   |   |   |   |   |   |   |   |
|---|---|---|---|---|---|---|---|---|---|---|---|---|---|---|---|---|---|---|---|---|---|---|---|---|---|---|---|---|---|---|---|---|---|---|---|---|---|
| 0 | 1 | 2 | 3 | 4 | 5 | 6 | 7 | 8 | 9 | - | □ | A | B | C | D | E | F | G | H | I | J | K | L | M | N | O | P | Q | R | S | T | U | V | W | X | Y | Z |
| 0 | 1 | 2 | 3 | 4 | 5 | 6 | 7 | 8 | 9 | - | □ | A | b | c | d | E | F | G | H | I | J | K | L | M | N | O | P | Q | R | S | T | U | V | W | X | Y | Z |

□ Space

## 11.2. GLP Report

Set the following parameters to output the report.

- Refer to "15.2. Connection to peripheral equipment" for connection to an AD-8121B.
- To print the report, set the "GLP output ( *inFo* )" parameter to "1" and use MODE 3 of the AD-8121B. If MODE1 is used, select temporary dump print mode by pressing the **[STAT.]** key of the AD-8121B.
- To output the report to a personal computer using the RS-232C interface, set the "GLP output ( *inFo* )" parameter to "2".
- If the time and date are not correct set the correct time and date in "Clock ( *CL Add* )" of the function table.

### Calibration report using the internal mass

#### Key operation

- 1 Press the **[CAL]** key to display **[CAL in]** and calibrate the balance automatically.
- 2 If GLP output is used, **[GLP]** is displayed and the calibration report is output.
- 3 The balance returns to weighing mode after this calibration.

Setting of " *inFo* 1"  
AD-8121 printer format

```

          A & D
MODEL     BM-300
S/N      01234567
ID       LAB-0123
DATE    2011/02/20
TIME     12:34:56
CALIBRATED (INT.)
SIGNATURE
-----
  
```

Setting of " *inFo* 2"  
General format

```

          A & D<TERM>
MODEL     BM-300<TERM>
S/N      01234567<TERM>
ID       LAB-0123<TERM>
DATE<TERM>
          2011/02/20<TERM>
TIME<TERM>
          12:34:56<TERM>
CALIBRATED (INT.)<TERM>
SIGNATURE<TERM>
<TERM>
<TERM>
          -----<TERM>
<TERM>
<TERM>
  
```

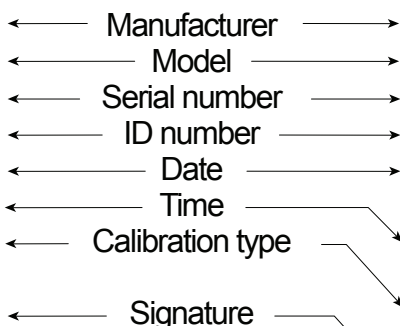

- ␣ Space, ASCII 20h
- <TERM> Terminator, CR , LF or CR
- CR Carriage return, ASCII 0Dh
- LF Line feed, ASCII 0Ah

# Calibration test report using an internal mass

**Note** Calibration test does not perform calibration.

## Key operation

- 1 Press and hold the `[CAL]` key to display `[EE in]` and release the key.
- 2 `[EE]` is displayed and the balance is tested automatically.
- 3 The zero point is measured and the weight value is displayed for a few seconds.
- 4 Internal mass is weighed and the weight value is displayed for a few seconds.
- 5 If GLP output is used, `[GLP]` is displayed and the calibration test report is output.
- 6 The balance returns to weighing mode after this test.

## Command

This calibration test report can be performed with command TST.

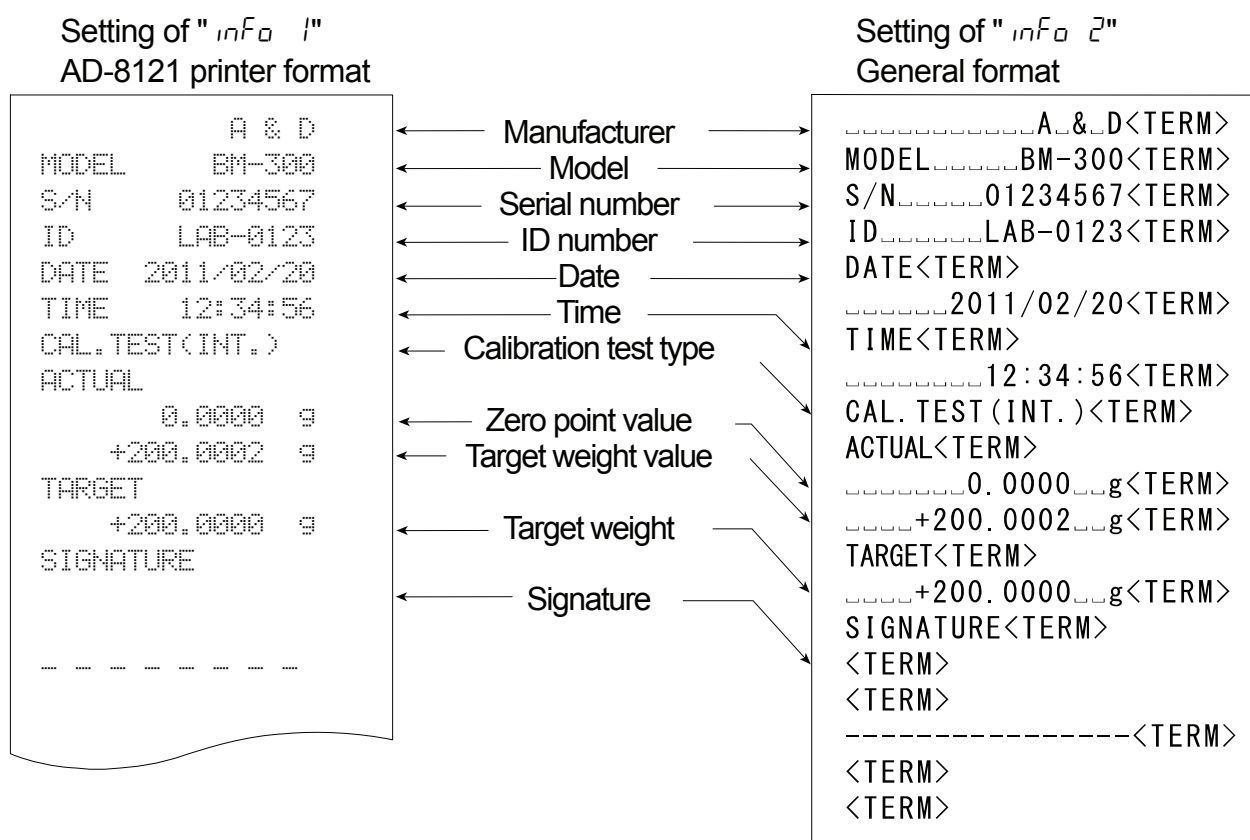

- ␣ Space, ASCII 20h
- <TERM> Terminator, CR , LF or CR
- CR Carriage return, ASCII 0Dh
- LF Line feed, ASCII 0Ah



# Calibration report using an external weight

## Key operation

- 1 Press and hold the **CAL** key to display **CAL out** and release the key.
- 2 **CAL 0** is displayed.
- 3 When updating the calibration mass value, press the **RANGE** key and proceed to step 4. When using the preset calibration mass value, proceed to step 5.
- 4 Specify calibration mass value using the following keys.
  - RANGE** key.....The key to select the blinking figure
  - RE-ZERO**(+)key...The key to increase the value of the blinking figure.
  - MODE**(-)key .....The key to decrease the value of the blinking figure.
  - PRINT** key .....The key to store the new value.
- 5 When pressing the **RE-ZERO** key, the zero point is measured and the weight value is displayed for a few seconds.
- 6 Place the displayed mass on the pan. Press the **PRINT** key to measure the mass and the weight value is displayed for a few seconds.
- 7 If GLP output is used, **GLP** is displayed and the calibration report is output.
- 8 The balance returns to weighing mode after this calibration.

Setting of "inF0 1"  
AD-8121 printer format

```

      A & D
MODEL  BM-300
S/N    01234567
ID     LAB-0123
DATE   2011/02/20
TIME   12:34:56
CALIBRATED(EXT.)
CAL.WEIGHT
      +200.0000  9
SIGNATURE
-----
    
```

Setting of "inF0 2"  
General format

```

.....A.&D<TERM>
MODEL.....BM-300<TERM>
S/N.....01234567<TERM>
ID.....LAB-0123<TERM>
DATE<TERM>
      2011/02/20<TERM>
TIME<TERM>
      12:34:56<TERM>
CALIBRATED(EXT.)<TERM>
CAL.WEIGHT<TERM>
.....+200.0000_g<TERM>
SIGNATURE<TERM>
<TERM>
<TERM>
-----<TERM>
<TERM>
<TERM>
    
```

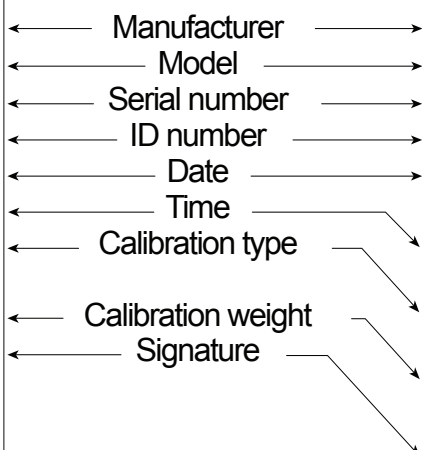

- ␣ Space, ASCII 20h
- <TERM> Terminator, CR, LF or CR
- CR Carriage return, ASCII 0Dh
- LF Line feed, ASCII 0Ah

# Calibration test report using an external weight

**Note** Calibration test does not perform calibration.

## Key operation

- 1 Press and hold the **[CAL]** key to display **[CAL out]** and release the key.
- 2 **[CAL 0]** is displayed.
- 3 When updating the target value, press the **[RANGE]** key and proceed to step 4.  
When using preset target value, proceed to step 5.
- 4 Specify calibration mass value using the following keys.  
**[RANGE]** key ..... The key to select the blinking figure  
**[RE-ZERO](+)**key .... The key to increase the value of the blinking figure.  
**[MODE](-)**key ..... The key to decrease the value of the blinking figure.  
**[PRINT]** key..... The key to store the new value.
- 5 When pressing the **[RE-ZERO]** key, the zero point is measured and the weight value is displayed for a few seconds.
- 6 Place the displayed mass on the pan. Press the **[PRINT]** key to measure the mass and the weight value is displayed for a few seconds.
- 7 If GLP output is used, **[GLP]** is displayed and the calibration test report is output.
- 8 The balance returns to weighing mode after this test.

Setting of "inF0 1"  
AD-8121 printer format

```

      A & D
MODEL   BM-300
S/N     01234567
ID      LAB-0123
DATE    2011/02/20
TIME    12:34:56
CAL. TEST (EXT.)
ACTUAL
      0.0000 g
      +200.0002 g
TARGET
      +200.0000 g
SIGNATURE
-----
  
```

Setting of "inF0 2"  
General format

```

.....A_&_D<TERM>
MODEL.....BM-300<TERM>
S/N.....01234567<TERM>
ID.....LAB-0123<TERM>
DATE<TERM>
.....2011/02/20<TERM>
TIME<TERM>
.....12:34:56<TERM>
CAL. TEST (EXT.)<TERM>
ACTUAL<TERM>
.....0.0000_g<TERM>
.....+200.0002_g<TERM>
TARGET<TERM>
.....+200.0000_g<TERM>
SIGNATURE<TERM>
<TERM>
<TERM>
-----<TERM>
<TERM>
<TERM>
  
```

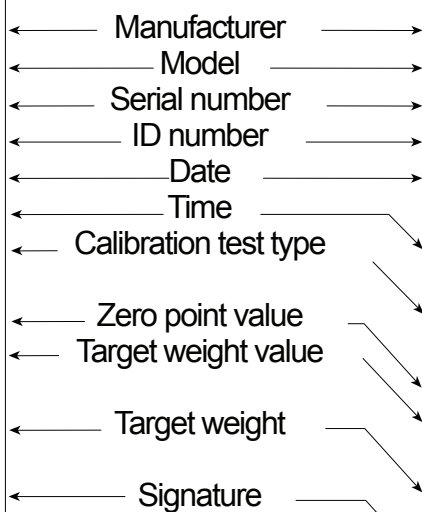

- ␣ Space, ASCII 20h
- <TERM> Terminator, CR , LF or CR
- CR Carriage return, ASCII 0Dh
- LF Line feed, ASCII 0Ah

## Title block and end block

When mass values are recorded as GLP data, a "Title block" is inserted at the beginning and an "End block" is inserted at the end of a group of mass values in the GLP report.

### Notes

- To output the report to an AD-8121B, use MODE 3 of the AD-8121B. If MODE1 is used, select temporary dump print mode by pressing the **STAT** key of the AD-8121B.
- If the data memory function is used (except *DATA 0*), the "Title block" and "End block" can not be output.

### Key operation

- 1 With the weighing data displayed, press and hold the **PRINT** key, then release the key. **Start** is displayed. The "Title block" is output.
- 2 The weighing data is output according to the parameter setting of the data output mode (*PrT*) of the function table.
- 3 Press and hold the **PRINT** key until **RecEnd** is displayed, then release the key. The "End block" is output.

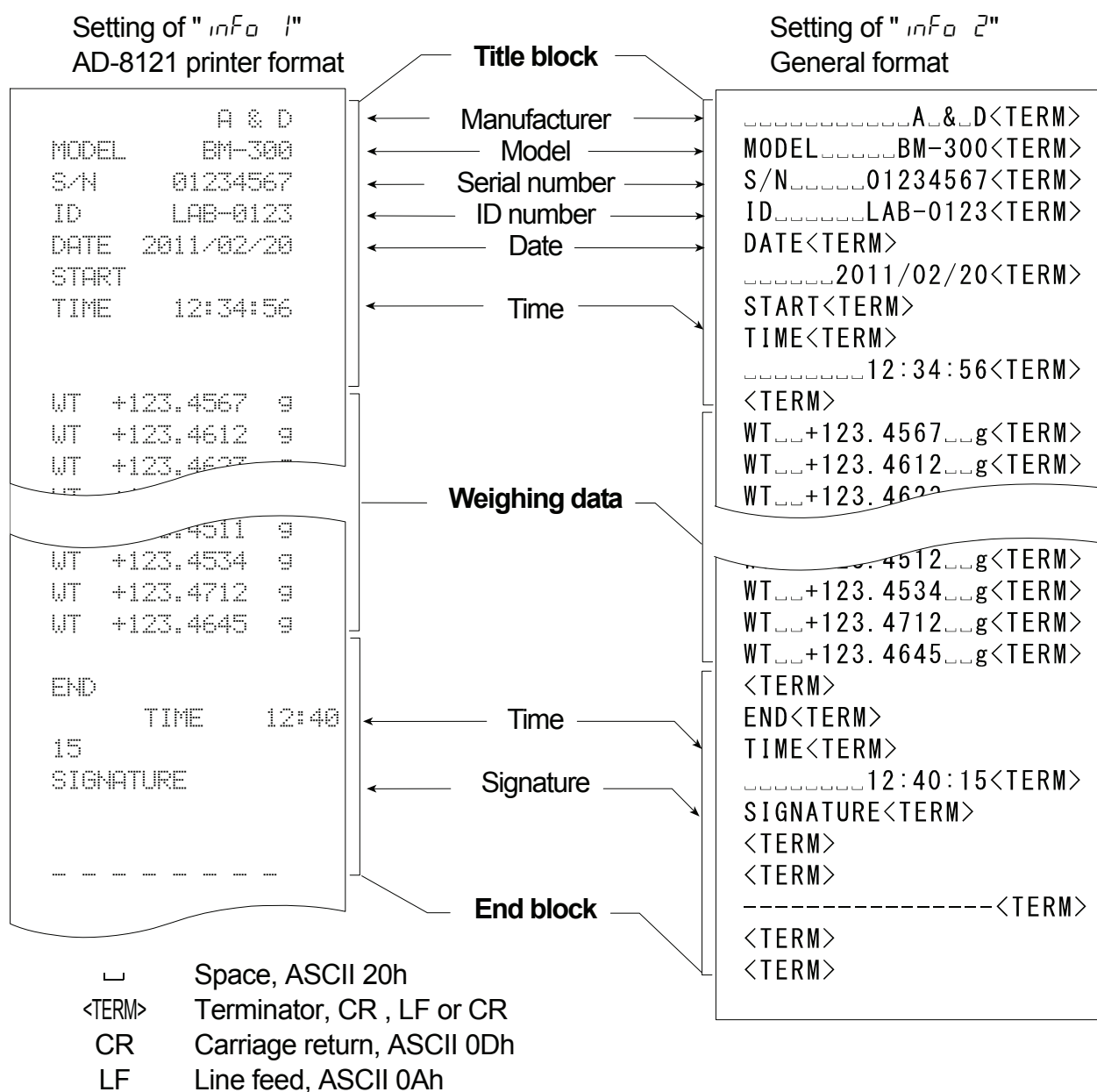

## 12. Data Memory

Data memory is a function to store weighing data and calibration data in memory. The data stored in memory are available for outputting at one time to a printer or personal computer.

|   |                         |                |
|---|-------------------------|----------------|
| Weighing data   | Excluding date and time | Up to 200 sets |
|   | Including date and time | Up to 100 sets |
| Calibration report<br>Internal calibration<br>External calibration                | Last 50 sets            |                |
| Calibration test report<br>Internal test calibration<br>External test calibration |                         |                |

### 12.1. Notes On Using Data Memory

- To use the memory function, set the "Data memory (dAtA)" parameter and "Time/Date output (S-tD)" parameter of the function table. Refer to "10. The Function Table" for details on setting the data memory.
- For weighing data, the data contents to be stored and the storage capacity depend on the "Time/Date output (S-tD)" parameter setting.
- If a different type of data exists in memory, "ELr" blinks in the upper left of the display.  
For example: You want to store weighing data but calibration data or unit mass data remains in memory. "ELr" blinks.
- If the stored data is incomplete or deleted, "Err" blinks in the upper left of the display.  
Under such a condition, before storing data, delete the data in memory as follows:

Upper left of the display



#### Releasing "ELr" or "Err"

- 1 Press and hold the **PRINT** key until **ELr no** with "no" blinking is displayed, then release the key.
- 2 Press the **RE-ZERO** key to display **ELr 0.0** with "0.0" blinking.  
The type of data stored in memory appears in the upper left of the display as shown below:

|                                     |     |
|-------------------------------------|-----|
| Weighing data without time and date | -d- |
| Weighing data with time and date    | d-t |
| Calibration report                  | HIS |

- 3 Press the **PRINT** key to delete all the data in memory.
- 4 The balance displays **End** and returns to the weighing mode.

## 12.2. Data Memory For Weighing Data

### Features

- The balance can store 200 sets of weighing data in memory (if time and date are added, the balance can store 100 sets). Even if the AC adapter is removed, the data is maintained in the memory.
- It is not necessary to connect a printer or personal computer to the balance continually, because the balance stores the weighing data in memory.
- The data memory function does not occupy a printer or personal computer while weighing.
- The data in memory can be displayed on the balance for confirmation.
- The data in memory can be output at one time to a printer or personal computer.

Comment: Select items for addition to the output data, such as the ID number, data number, time and date, in the function settings.

### Storing the weighing data

**Note** If "CL" blinks in the upper left of the display, delete the data in memory.

- 1 Set the "Data memory (dAtA)" parameter to "1".
- 2 Specify the "Time/Date output (S-tD)" parameter whether time and date is to added or not.
- 3 The storing mode depends on the "Data output mode (P-r-t)" parameter setting.  
Four modes are available to store data.

- Key mode .....When the PRINT key is pressed and the displayed value is stable, the balance stores the weighing data.
- Auto print mode A .....When the displayed value is stable and the conditions of "Auto print polarity", "Auto print difference" and zero point (reference value) are met, the balance stores the weighing data.
- Auto print mode B .....When the displayed value is stable and the conditions of "Auto print polarity", "Auto print difference" and last stable data (reference value) are met, the balance stores the weighing data.
- Interval mode .....Weighing data is stored at an interval specified in "Interval time (int)". Press the PRINT key to start and stop this mode.

### Display Symbols For Data Memory

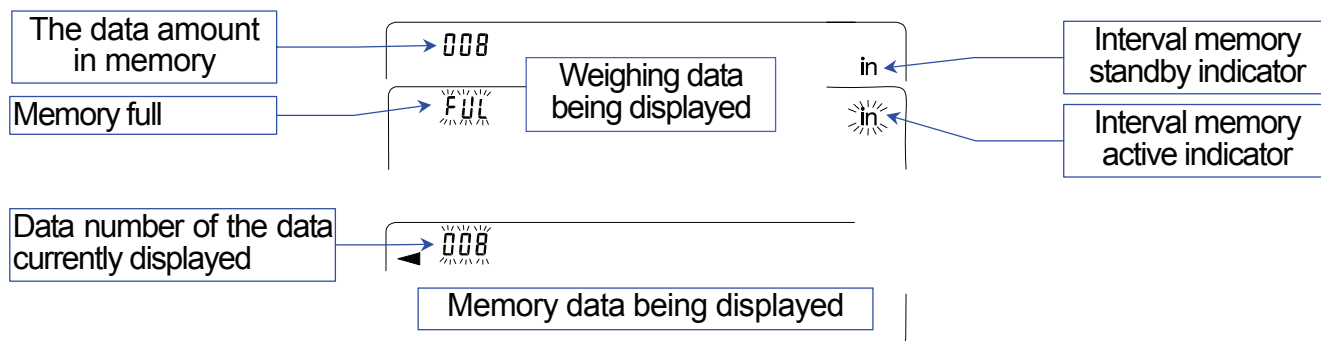

## Caution

- When weighing data is being stored in memory, the data can be output to a personal computer using the RS-232C interface at the same time.
- "FULL" indicates that memory is full or the memory capacity has been reached. More data can not be stored unless the memory data is deleted.
- Automatic self calibration can not be used while the interval memory mode is active.
- The following commands can not be used during data storage.
  - Q      Query command for weighing data.
  - S      Query command for stable weighing data.
  - SI     Query command for weighing data.
  - SIR    Query command for continuous weighing data.

## Setting the function table

Parameter settings for each output mode are as follows:

| Mode \ Item       | Data output mode | Auto print polarity, difference | Data memory function | Interval time     |
|-------------------|------------------|---------------------------------|----------------------|-------------------|
| Key mode          | <i>Prt 0</i>     | Not used                        | <i>dAtA 1</i>        | Not used          |
| Auto print mode A | <i>Prt 1</i>     | <i>AP-A 0 to 2</i>              | <i>dAtA 1</i>        |                   |
| Auto print mode B | <i>Prt 2</i>     | <i>AP-b 0 to 2</i>              | <i>dAtA 1</i>        |                   |
| Interval mode     | <i>Prt 3</i>     | Not used                        | <i>dAtA 1</i>        | <i>int 0 to 8</i> |

Additional parameter settings, as follows:

|             |     |                 |               |           |               |          |
|-------------|-----|-----------------|---------------|-----------|---------------|----------|
| Data number | No  | <i>d-no off</i> | Time and date | No        | <i>S-td 0</i> | 200 sets |
|             | Yes | <i>d-no on</i>  |               | Time only | <i>S-td 1</i> | 100 sets |
| ID number   | No  | <i>S-id off</i> |               | Date only | <i>S-td 2</i> |          |
|             | Yes | <i>S-id on</i>  |               | Both      | <i>S-td 3</i> |          |

## Enabling the data memory function

- 1 Press and hold the **RANGE** key until **bRSFnc** is displayed, then release the key.
- 2 Press the **RANGE** key several times to display **dout**.
- 3 Press the **PRINT** key.
- 4 Press the **RANGE** key three times to display **dAtA**.
- 5 Press the **RE-ZERO** key to display **dAtA 1**.
- 6 Press the **PRINT** key to store the setting.
- 7 Press the **CAL** key to return to the weighing mode.

## Recalling the memory data

Confirm that the "Data memory (dAtA)" parameter is set to "I".

- 1 Press and hold the **PRINT** key until **rEeALL** is displayed, then release the key.
- 2 Press the **PRINT** key to enter the memory recall mode. The type of data appears in the upper left of the display as shown to the right. Recall the data in memory using the following keys.
  - RE-ZERO** key.....To proceed to the next data set.
  - MODE** key .....To go back to the previous data set.
  - PRINT** key.....To transmit the current data using the RS-232C interface.

With **RANGE** held down, press the **CAL** key  
To delete the current data.

**CAL** key.....To exit the memory recall mode.
- 3 Press the **CAL** key to return to the weighing mode.

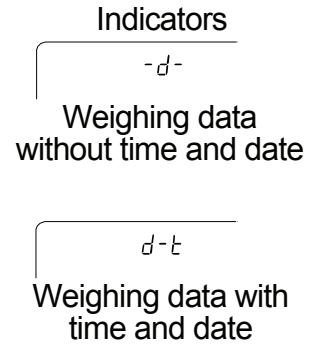

## Transmitting all memory data at one time

Confirm that the "Serial interface (SIF)" parameters are set properly.

Refer to "10. Function Table" and "15.2. Connection To Peripheral Equipment".

- 1 Press and hold the **PRINT** key until **rEeALL** is displayed, then release the key.
- 2 Press the **RANGE** key to display **out**.
- 3 Press the **PRINT** key to display **out no** with "no" blinking.
- 5 Press the **RE-ZERO** key to display **out 00** with "00" blinking.
- 6 Press the **PRINT** key to transmit all data using the RS-232C interface.
- 7 The balance displays **CLER** when all data is transmitted. Press the **CAL** key to return to the weighing mode.

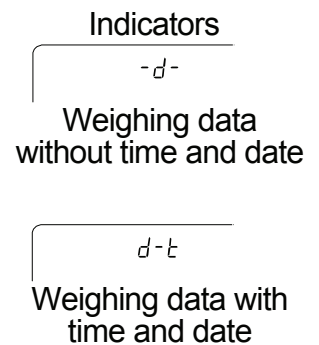

## Deleting all memory data at one time

- 1 Press and hold the **PRINT** key until **rEeALL** is displayed, then release the key.
- 2 Press the **RANGE** key several times to display **CLER**.
- 3 Press the **PRINT** key to display **CLr no** with "no" blinking.
- 4 Press the **RE-ZERO** key to display **CLr 00** with "00" blinking.
- 5 Press the **PRINT** key to delete all data
- 6 The balance displays **End** and returns to the weighing mode.

## 12.3. Data Memory For Calibration And Calibration Test

### Features

- Calibration data (when and how it is performed) and calibration test data can be stored in memory.
- All the data in memory is available to be output at one time to a printer or personal computer.
- Up to 50 data sets of the latest calibration or calibration test can be stored. When the memory capacity has been reached, "FUL" is displayed in the upper left of the display.

Indicator

FUL

### Storing the calibration and calibration test data

**Note** If "CLR" appears blinking in the upper left of the display, delete the data in memory.

Store the calibration and calibration test data as follows:

- 1 Set the "Data memory (dAtA)" parameter to "2".
- 2 Set the "GLP output (oF)" parameter to "1" or "2".
- 3 With the settings above, each time calibration or calibration test is performed, the data is stored automatically.

### Transmitting the memory data

#### Note

- **Confirm that the "Serial interface (SIF)" parameters are set properly.** Refer to "10. Function Table" and "15.2. Connection To Peripheral Equipment".
- **Confirm that the "Data memory" parameter is set to "dAtA 2".**

- 1 Press and hold the **PRINT** key until **out** is displayed, then release the key.
- 2 Press the **PRINT** key to display **out no** with "no" blinking.
- 3 Press the **RE-ZERO** key to display **out Go** with "Go" blinking.
- 4 Press the **PRINT** key to transmit all memory data using the RS-232C interface.
- 5 The balance displays **CLEAR** when all memory data is output.  
Press the **CAL** key to return to the weighing mode.

In the upper left  
of the display

H15

Calibration report

### Deleting data stored in memory

- 1 Press and hold the **PRINT** key until **out** is displayed, then release the key.
- 2 Press the **SAMPLE** key to display **CLEAR**.
- 3 Press the **PRINT** key to display **Clr no** with "no" blinking.
- 4 Press the **RE-ZERO** key to display **Clr Go** with "Go" blinking.
- 5 Press the **PRINT** key to delete all data.
- 6 The balance displays **out** and returns to the weighing mode when all the data has been deleted.

In the upper left  
of the display

H15

Calibration report



# 13. Underhook

The underhook can be used for magnetic materials or density measurement. The built-in underhook is revealed by removing the cap on the bottom of the balance. Use the underhook as shown below.

## Caution

- Do not apply excessive force to the underhook.
- When not in use, attach the cap to prevent dust from getting into the balance.
- Do not push the underhook upward
- When turning the balance over, parts and weighing matter in the weighing chamber will fall off. (Parts: the weighing pan, pan support, breeze break ring, fine range ring and dust plate )  
Remove them first.
- When the cap is removed, a weighing error may occur, because of drafts entering into the internal portion of the balance. Arrange the room condition.

- 1 Remove the cap on the bottom of the balance.
- 2 Hang your weighing pan on the underhook.  
Place the balance on the solid table.

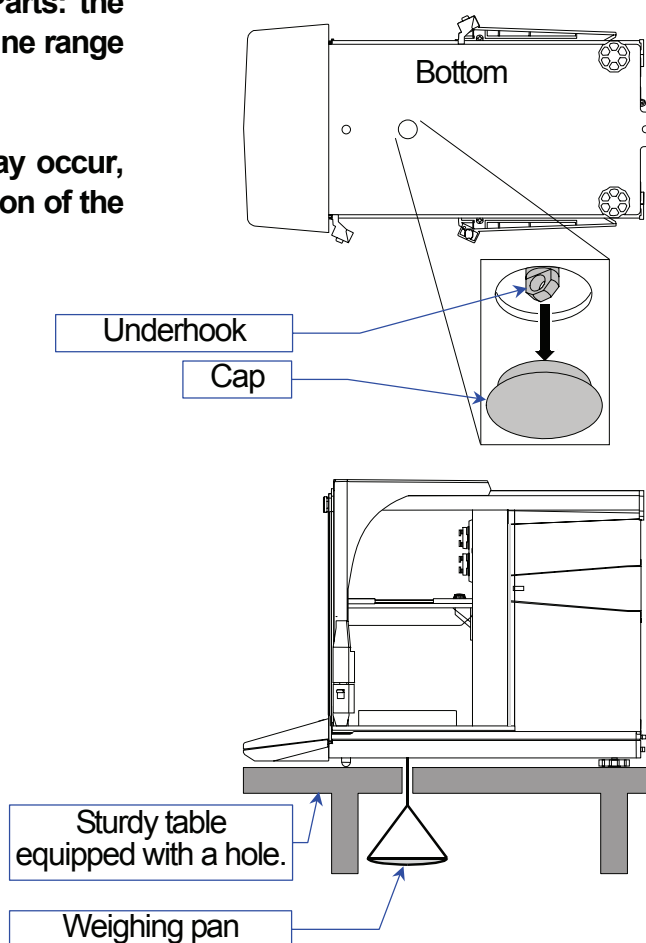

# 14. Density Measurement (Specific gravity)

The balance is equipped with a density mode. It calculates the density of a solid using the mass value of a sample in air and the mass value in liquid. We recommend the use of the AD-1653 Density Determination Kit.

## Note

- The density mode was not selected for use when the balance was shipped from the factory. To use this mode, change the function table settings to activate the density mode. Refer to "5.2. Storing Active Units".
- When the density mode is selected, the response adjustment function can not be used.
- The minimum display is 0.0001 g while using the density mode.

## Formula to obtain the density

The density can be obtained by the following formula.

$$\rho = \frac{A}{A - B} \times \rho_0$$

Where

- $\rho$  : Density of a sample
- A : Mass value of a sample in air
- B : Mass value of a sample in liquid
- $\rho_0$  : Density of a liquid

## Prior to measurement: Changing the function table

Prior to measurement, change the function table as follows:

- 1 Selecting the density mode.

The density mode is available as one of the weighing units.

Select it by pressing the **MODE** key. To use the mode, select it (unit of **Unit 15**.) in the function table. Refer to "5.2. Storing The Active Units".

- 2 Selecting a way to set the density of a liquid.

Select the liquid density input method from the function table below.

## Note

The following function table is displayed only when the unit of **Unit 15** is active. The table of the density mode (**d5 Fnc**) is displayed next **5 if**.

| Class                      | Item and Parameter   | Description       |
|----------------------------|----------------------|-------------------|
| d5 Fnc<br>Density function | Ld in                | Water temperature |
|                            | Liquid density input | Liquid density    |

▪ is factory setting.

## Entering the density of a liquid

Two ways to set the density of a liquid are available in the function table, "Liquid density input ( $Ld_{in}$ ): by entering the water temperature or by entering the density directly.

- Press the **MODE** key as necessary to select the density mode.  
Press and hold the **MODE** key to select to "water temperature" or "liquid density".  
In the density mode : The unit is "g (gram)". The processing indicator (◀) blinks.  
Response adjustment is off.  
If you cancel the density mode, press the **MODE** key.

0.0000 g

### Entering the water temperature ( $Ld_{in} \text{ } \bar{D}$ )

- The water temperature currently set (unit:°C, factory setting : 25°C) is displayed.  
Use the following keys to change the value.

25

**RE-ZERO**(+)key .... The key to increase the temperature by one degree.  
(0°C is displayed after 99°C)

**MODE**(-)key ..... The key to decrease the temperature by one degree.  
(99°C is displayed after 0°C)

**PRINT** key..... The key to store new water temperature, display **End** and return to the density mode. Proceed to Step 1.

**CAL** key..... The key to cancel the change and return to the density mode.  
Proceed to Step 1.

## The relation between the water temperature and density

| °C | +0      | +1      | +2      | +3      | +4      | +5      | +6      | +7      | +8      | +9      |
|----|---------|---------|---------|---------|---------|---------|---------|---------|---------|---------|
| 0  | 0.99984 | 0.99990 | 0.99994 | 0.99996 | 0.99997 | 0.99996 | 0.99994 | 0.99990 | 0.99985 | 0.99978 |
| 10 | 0.99970 | 0.99961 | 0.99949 | 0.99938 | 0.99924 | 0.99910 | 0.99894 | 0.99877 | 0.99860 | 0.99841 |
| 20 | 0.99820 | 0.99799 | 0.99777 | 0.99754 | 0.99730 | 0.99704 | 0.99678 | 0.99651 | 0.99623 | 0.99594 |
| 30 | 0.99565 | 0.99534 | 0.99503 | 0.99470 | 0.99437 | 0.99403 | 0.99368 | 0.99333 | 0.99297 | 0.99259 |
| 40 | 0.99222 | 0.99183 | 0.99144 | 0.99104 | 0.99063 | 0.99021 | 0.98979 | 0.98936 | 0.98893 | 0.98849 |
| 50 | 0.98804 | 0.98758 | 0.98712 | 0.98665 | 0.98618 | 0.98570 | 0.98521 | 0.98471 | 0.98422 | 0.98371 |
| 60 | 0.98320 | 0.98268 | 0.98216 | 0.98163 | 0.98110 | 0.98055 | 0.98001 | 0.97946 | 0.97890 | 0.97834 |
| 70 | 0.97777 | 0.97720 | 0.97662 | 0.97603 | 0.97544 | 0.97485 | 0.97425 | 0.97364 | 0.97303 | 0.97242 |
| 80 | 0.97180 | 0.97117 | 0.97054 | 0.96991 | 0.96927 | 0.96862 | 0.96797 | 0.96731 | 0.96665 | 0.96600 |
| 90 | 0.96532 | 0.96465 | 0.96397 | 0.96328 | 0.96259 | 0.96190 | 0.96120 | 0.96050 | 0.95979 | 0.95906 |

g/cm<sup>3</sup>

### Entering the density directly ( $Ld_{in} \text{ } I$ )

The density currently set (unit : g / cm<sup>3</sup>, factory setting : 1.0000g / cm<sup>3</sup>) is displayed.

d 1.0000

Use the following keys to change the value.

The range to set the density is 0.0000g / cm<sup>3</sup> to 1.9999g / cm<sup>3</sup>.

**RE-ZERO**(+)key.... The key to set the value of the digit selected.

**RANGE**(-)key..... The key to select the digit to change the value.

**PRINT** key..... The key to store the change, display **End** and return to the density mode.  
Proceed to Step 1.

**CAL** key..... The key to cancel the change and return to the density mode. Proceed to Step 1.

## Measuring the density ( specific gravity )

**Note** If the liquid temperature or the type of liquid is changed during measurement, again input the value of the liquid density as necessary. The density display is four decimal places. The minimum display can not be changed with the **[RANGE]** key.

The density (or specific gravity) is displayed after "Mass measurement in air" and "Mass measurement in liquid".

The procedure of each measurements is as follows:

g : gram. ◀ : the processing indicator.

1 Enter the density mode. (g lights. ◀ blinks.)  
Place nothing on both pan and press the **[RE-ZERO]** key to display zero.

2 Place the sample on the pan in air. (g lights. ◀ blinks.)  
If the weight value is stored or output, press the **[PRINT]** key to store it after a stable weight value is displayed.  
Press the **[RANGE]** key to decide the weight value in air and proceed to next step.

**Note** If negative value or **[E]** (out of range) is displayed, the **[RANGE]** key is inactive.

3 Move the sample to the pan in liquid. (g lights. ◀ lights.)  
If the weight value is stored or output, press the **[PRINT]** key to store it after a stable weight value is displayed.  
Press the **[RANGE]** key to decide the weight value in liquid and proceed to next step.

**Note** If **[E]** (out of range) is displayed, the **[RANGE]** key is inactive.

4 If the density value is stored or output, press the **[PRINT]** key to store it. (Unit :  $\rho$ . g turns off. ◀ lights.)  
Press the **[RANGE]** key to measure another sample and proceed to step 2.

5 If the liquid temperature or the type of liquid is changed during measurement, input again the value of the liquid density as necessary.

6 Press the **[MODE]** key to proceed to other modes.

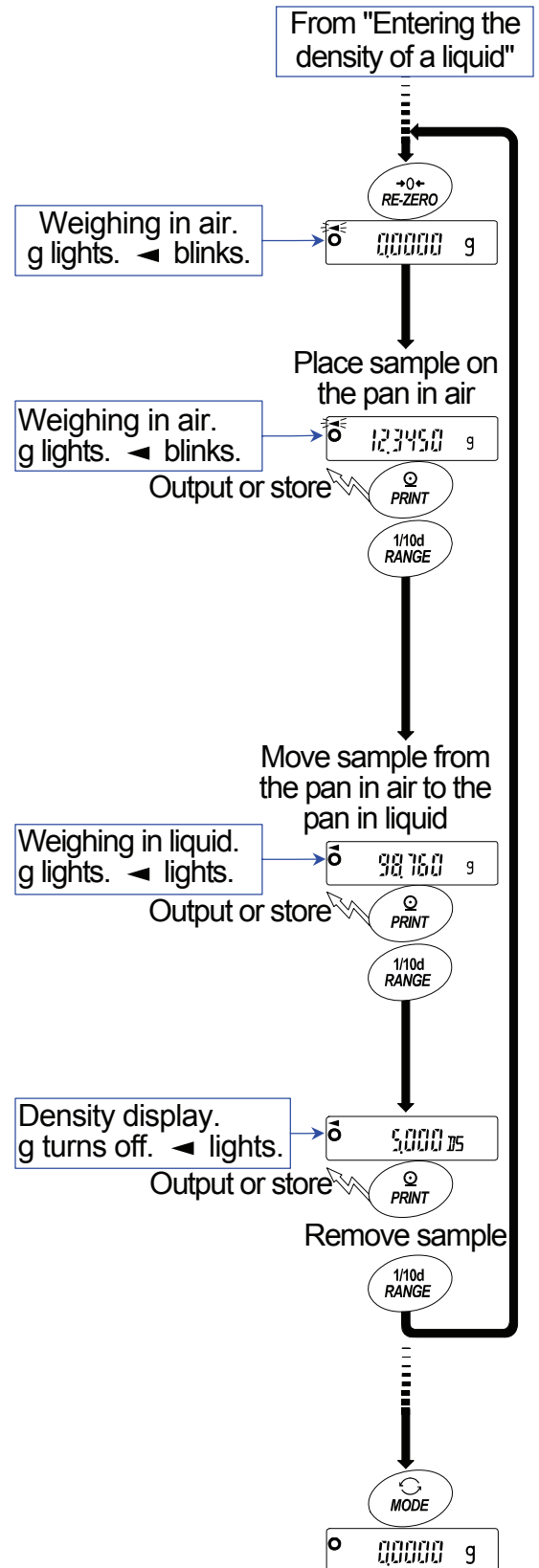

# 15. Standard Input And Output Interface

## 15.1. RS-232C Interface

The balance is a DCE device. Connect the balance to a personal computer (DTE) using a straight through cable.

- Transmission system : EIA RS-232C
- Transmission form : Asynchronous, bi-directional, half duplex
- Transmission rate : 10 times/second or 5 times/second (same as data refresh rate)
- Data format : Baud rate : 600, 1200, 2400, 4800, 9600, 19200bps
- Data bits : 7 or 8 bits
- Parity : Even, Odd (Data bits 7 bits)
- None (Data bits 8 bits)
- Stop bit : 1 bit
- Code : ASCII

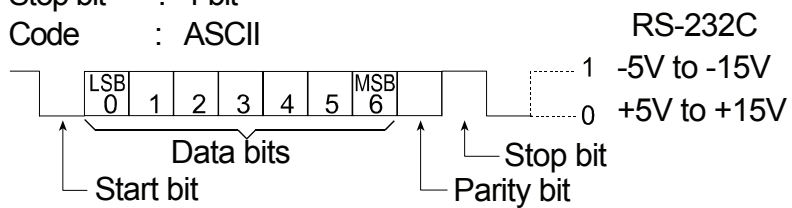

### D-Sub 9 pin assignments

| Pin No. | Signal name | Direction | Description     |
|---------|-------------|-----------|-----------------|
| 1       | -           | -         | No connection   |
| 2       | TXD         | Output    | Transmit data   |
| 3       | RXD         | Input     | Receive data    |
| 4       | -           | -         | No connection   |
| 5       | SG          | -         | Signal ground   |
| 6       | DSR         | Output    | Data set ready  |
| 7       | RTS         | Input     | Request to send |
| 8       | CTS         | Output    | Clear to send   |
| 9       | -           | -         | No connection   |

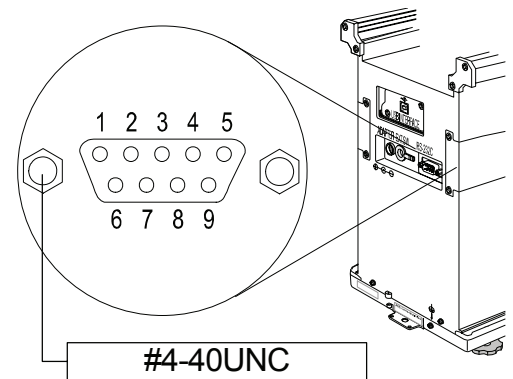

Signal names of the balance side are the same as the DTE side with TXD and RXD reversed.

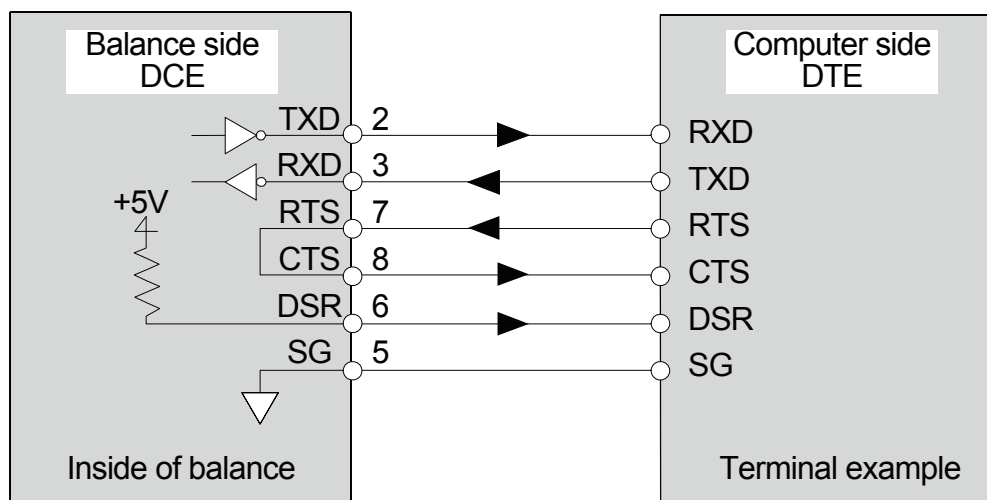

## 15.2. Connection To Peripheral Equipment

### Connection to an AD-8121B printer

Preset the following parameters to use the AD-8121B printer.

| Class                           | Item and Parameter                   | Factory settings | AD-8121B MODE 1 | AD-8121B MODE 2 | AD-8121B MODE 3 |
|---------------------------------|--------------------------------------|------------------|-----------------|-----------------|-----------------|
| <i>dout</i><br>Data output      | <i>Prt</i><br>Data output mode       | 0                | 0, 1, 2         | 3               | 0, 1, 2         |
|                                 | <i>RP-P</i><br>Auto print polarity   | 0                | #1              | Not necessary   | #1              |
|                                 | <i>RP-b</i><br>Auto print difference | 1                |                 |                 |                 |
|                                 | <i>S-id</i><br>ID number output      | 0                | off             | off             | off, on         |
|                                 | <i>d-no</i><br>Data number output    | 0                | off             | off             | off, on         |
|                                 | <i>S-td</i><br>Time/Date output      | 0                | 0               | 0               | 0, 1, 2, 3      |
|                                 | <i>PUSE</i><br>Data output pause     | 0                | off             | off             | off, on #2      |
|                                 | <i>Rt-F</i><br>Auto feed             | 0                | off             | off             | off, on         |
| <i>S,IF</i><br>Serial interface | <i>bPS</i><br>Baud rate              | 2                | 2               | 2               | 2               |
|                                 | <i>btPr</i><br>Data bit, parity bit  | 0                | 0               | 0               | 0               |
|                                 | <i>CrLF</i><br>Terminator            | 0                | 0               | 0               | 0               |
|                                 | <i>tYPE</i><br>Data format           | 0                | 0               | 0               | 1               |

#1 Set parameters when auto print mode A or B (*Prt* 1 or 2) is selected.

#2 Set 1 when multiple lines are printed. Example: When appending ID number, set 1.

#### Notes

- Refer to "11.2. GLP Report" concerning print samples.
- Settings of AD-8121B

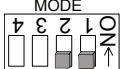
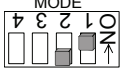
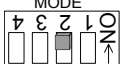
| MODE   | AD-8121B DIP switch   | Description   |
|--------|---|---|
| MODE 1 |  | Print at receiving data.<br>Standard mode, statistic mode   |
| MODE 2 |  | Print by <b>DATA</b> key operation or built-in timer.<br>Standard mode, interval mode, chart mode |
| MODE 3 |  | Print at receiving data.<br>Dump print mode   |

DIP switch No.3 : Handling unstable data

ON Print

OFF Not printed

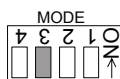

DIP switch No.4 : Data input specifications (Interface selection)

ON Current loop

OFF RS-232C

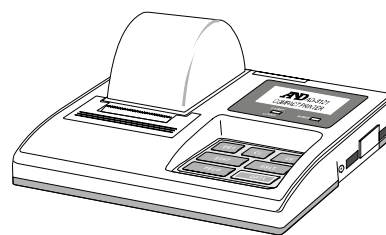

## Connection to a computer using the RS-232C Interface

### Features

The balance is of the DCE type (Data Communication Equipment), which can be connected to a personal computer using the RS-232C interface. Before connection, read the personal computer manual thoroughly. Use a standard DCE cable for connection (cable type: straight-through).

### Using Windows Communication Tools Software (WinCT)

When Windows is used as an operating system in a personal computer, the provided WinCT software can be used to transmit the weighing data to the personal computer.

The WinCT software has two communication methods: "RsCom" and "RsKey". Refer to the WinCT instruction manual.

The current version of the WinCT can be downloaded from the A&D website.

### RsCom

- RsCom can transmit commands to control the balance.
- RsCom can make bi-directional communication between the balance and a personal computer using the RS-232C interface.
- RsCom can display or store the data using a text file format. RsCom can also print the data using a printer connected to the personal computer.
- When several ports of a personal computer have balances connected, the personal computer can communicate with each balance simultaneously.
- RsCom can share a personal computer with other application software.
- RsCom can receive the balance GLP report.

### RsKey

- RsKey can transmit the weighing data output from the balance directly to other application software such as Microsoft Excel.
- RsKey can be used with most application software.
- RsKey can receive the balance GLP report.

### Using the WinCT software, the balance can do the following:

- **Analyzing the weighing data and the statistics input by "RsKey"**

The weighing data can be input directly into an Excel worksheet. Then, Excel can analyze the data to obtain total, average, standard deviation, maximum and minimum value, and display them in a graph.
- **Controlling the balance using commands from a personal computer**

By using "RsCom", the personal computer sends commands such as "re-zero" or "send weighing data" to the balance and controls the balance.
- **Printing the balance GLP report using your printer**

The balance GLP report can be printed using a printer connected to the personal computer.
- **Receiving weighing data at a certain interval**

The weighing data can be received at a certain interval and data characteristic with elapsed time can be obtained.
- **Using the balance memory function**

The data can be stored in the balance's memory. Of the data stored, the weighing data and calibration data can be transmitted to a personal computer at one time.
- **Using a personal computer as an external indicator**

With the "RsKey" test mode function, a personal computer can be used as an external weight indicator for the balance. (To do this, set the balance data output mode to stream mode.)

## Connection to a computer using the USB Interface

### Features

- The weighing data can be transmitted to a personal computer when connecting the balance and personal computer by the USB interface. The operation system must be Windows 98 or a later version.
- The USB interface uses standard device driver software and does not require installation of special driver software. When simply using the USB interface and cable, weighing data can be transmitted.
- The data can be transmitted to most application software (ex.: EXCEL, WORD, note pad).

### Cautions

- **The balance can transmit the weighing data without the header and unit.**
- **The USB Interface of the balance can not receive the command that controls the balance. When using the command, connect to the RS-232C interface of the balance. When connecting the USB Interface of a personal computer to the RS-232C interface of the balance, use the USB converter (AX-USB-9P).**
- **Do not use the screensaver or suspend mode of a personal computer.**

### Using the USB Interface

- 1 Start the Windows of the personal computer.  
Connect the AC adaptor to the balance and turn on the display with the  ON:OFF key.
- 2 Connect the personal computer to the balance using the USB cable.  
**Note: Do not use stream mode of data output mode (*dout, Prt 3*).**
- 3 At the first connection only, the USB driver software is automatically installed.
- 4 Open the application (ex.: EXCEL) that is to receive the weighing data.  
Move the cursor onto the position to input the weighing data.
- 5 Press the  PRINT key to input the weighing data at the position of the cursor.
- 6 When finishing the operation, remove the USB cable.

### Examples

- **Case 1: Transmitting the weighing data with key operation**  
Data output mode of the balance: Key mode (factory settings), *dout, Prt 0*  
When pressing the  PRINT key, the weighing data is transmitted.  
It is a basic use.
- **Case 2: Transmitting the stable weighing data**  
Data output mode of the balance: Auto print mode A and B, *dout, Prt 1 and 2*  
When placing a sample of weighing matter and displaying the stabilization indicator  O, the weighing data is transmitted.  
This mode is useful when repeating the weighing.
- **Case 3: Transmitting the weighing data periodically**  
Data output mode of the balance: Interval mode, *dout, Prt 3, dAtA 1 and int*  
The weighing data is transmitted periodically.  
The interval time: 2, 5, 10, 30 seconds, 1, 2, 5, 10 minutes.



## 15.3. Commands

### 15.3.1. Command List

**Note** A command has a terminator added, that is specified using "SIF, CrLF" of the function table, and is sent to the balance.

| Commands to query weighing data |   |
|---------------------------------|---|
| C                               | Cancels the S or SIR command.               |
| Q                               | Requests the weighing data immediately.     |
| S                               | Requests the weighing data when stabilized. |
| SI                              | Requests the weighing data immediately.     |
| SIR                             | Requests the weighing data continuously.    |

| Commands to control the balance |   |
|---------------------------------|---|
| CAL                             | Same as the <span style="border: 1px solid black; padding: 2px;">CAL</span> key. Calibration using the internal mass. |
| OFF                             | Turns the display off.  |
| ON                              | Turns the display on.   |
| P                               | Same as the <span style="border: 1px solid black; padding: 2px;">ON:OFF</span> key. Turing the display on or off.     |
| PRT                             | Same as the <span style="border: 1px solid black; padding: 2px;">PRINT</span> key.                                    |
| R                               | Same as the <span style="border: 1px solid black; padding: 2px;">RE-ZERO</span> key. Zero display. #1                 |
| RNG                             | Same as the <span style="border: 1px solid black; padding: 2px;">RANGE</span> key. Changing the minimum display.      |
| TR                              | Tares the balance. Canceling the container's weight.. #1  |
| TST                             | Perform calibration test.. Calibration test using the internal mass.  |
| U                               | Same as the <span style="border: 1px solid black; padding: 2px;">MODE</span> key. Changing the unit.                  |

| Commands to request data |   |
|--------------------------|---|
| ?ID                      | Requests the identification number.       |
| ?PT                      | Outputs the tare value. #1                |
| ?SN                      | Request the serial number of the balance. |
| ?TN                      | Request the model name of the balance.    |

| Command to set data   |                         |
|---|-------------------------|
| PT:***.**** <span style="border: 1px solid black; padding: 2px;">g</span> | Sets the tare value. #1 |

- #1
- Command R assumes the point as zero and sets the display to zero.
  - Command TR cancels the tare weight when the displayed value is greater than zero. The canceled tare value can be read using the command ?PT.
  - Command PT:\*\*\*.\*\*\*\* g sets the tare value digitally. An example of this command sets a negative target value and fills with the sample until the display becomes zero. For details, refer to page 75.
    - Step 1 Place a container.
    - Step 2 Set the display to zero using the R command.
    - Step 3 Set a target value using the PT: command.

## 15.3.2. Acknowledge Code And Error Codes

---

When the "Serial interface function (*SIF*)" parameter is set to "Error *Ed on*", the balance outputs <AK> code or error code to each command as follows:

<AK> (06h)            Acknowledge in ASCII code.

- When the balance receives a command to request data and can not process it, the balance transmits an error code (EC, E $xx$ ).

When the balance receives a command to request data and can process it, the balance outputs the data.

- When the balance receives a command to control the balance and can not process it, the balance transmits an error code (EC, E $xx$ ).

When the balance receives a command to control the balance and can process it, the balance transmits the acknowledge code.

<AK> (06h)            Acknowledge in ASCII code.

Among commands to control the balance, the following transmit the acknowledge code both when the balance receives the command and when the balance has accomplished the command.

If the command can not be processed properly, the balance transmits an error code (EC, E $xx$ ).

This error can be released using the CAL command.  $xx$  is error code number.

|             |   |
|-------------|---|
| CAL command | (Calibration command using internal mass) |
| ON command  | (Display ON command)                      |
| P command   | (Display ON/OFF command)                  |
| R command   | (RE-ZERO command)                         |
| TR command  | (Tare command)                            |
| TST command | (Calibration test command)                |

- When a communication error has occurred due to external noise, or a parity error has occurred due to transmission error, the balance transmits an error code (EC, E $xx$ ). In this case, send the command again.  $xx$  is error code number.

## 15.3.3. Settings Related To RS-232C

---

Concerning the RS-232C, the balance has two functions: "Data output (*dout*)" and "Serial interface (*SIF*)". Set each function as necessary.

### 15.3.4. Command Examples

This example uses the "Error" of "5IF" so that the <AK> (06h) code is output.

#### ON command (turning on the balance)

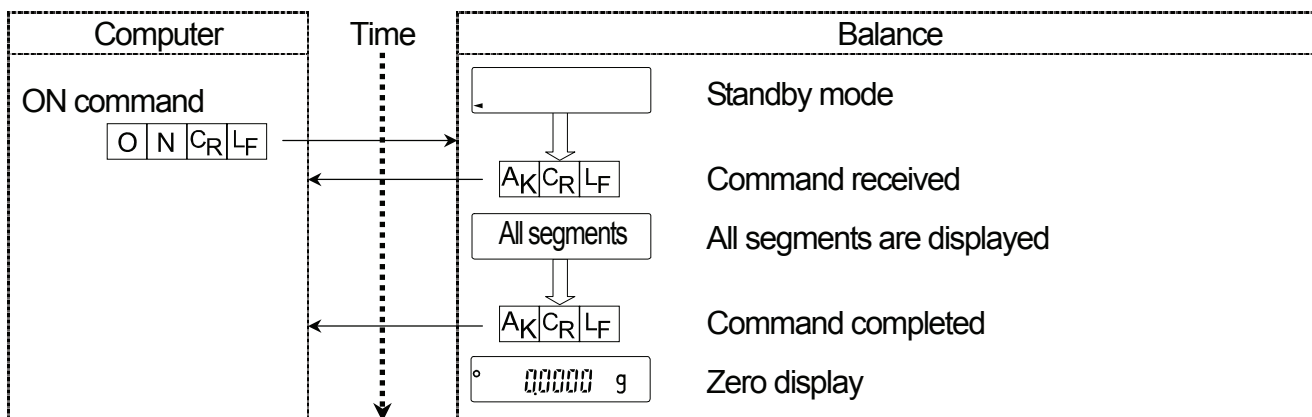

#### R command (Re-zeroing the display)

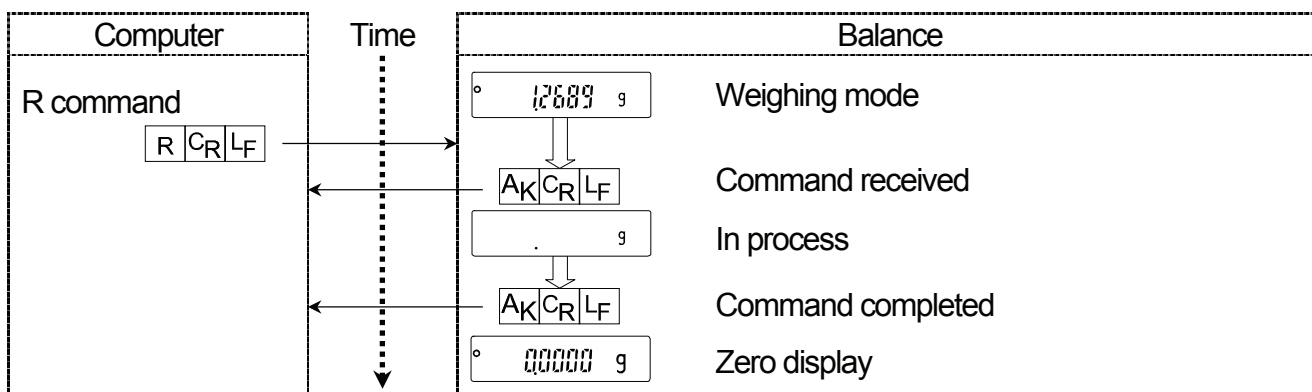

#### CAL command (Calibration with internal mass)

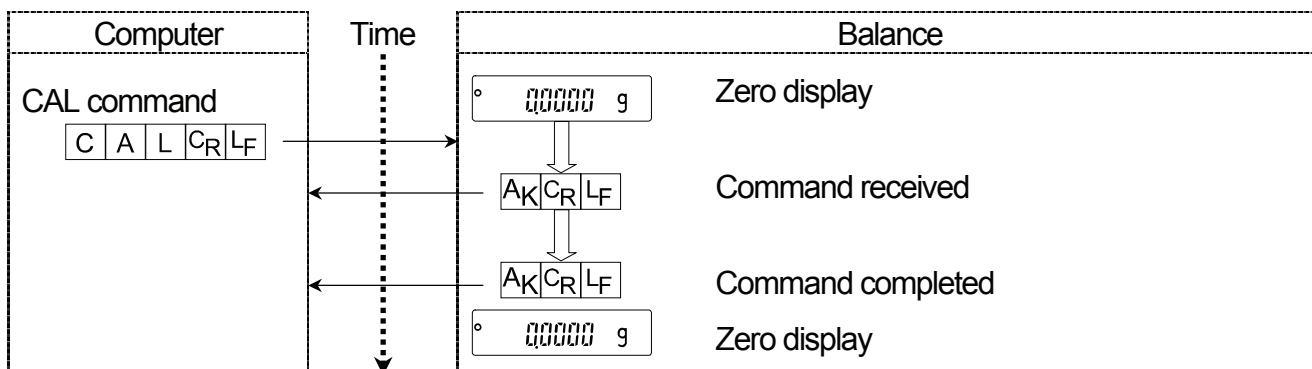

## Error code

This example is of an error using the R command. "Error 1" is used. The balance transmits an error code when the received command can not be achieved.

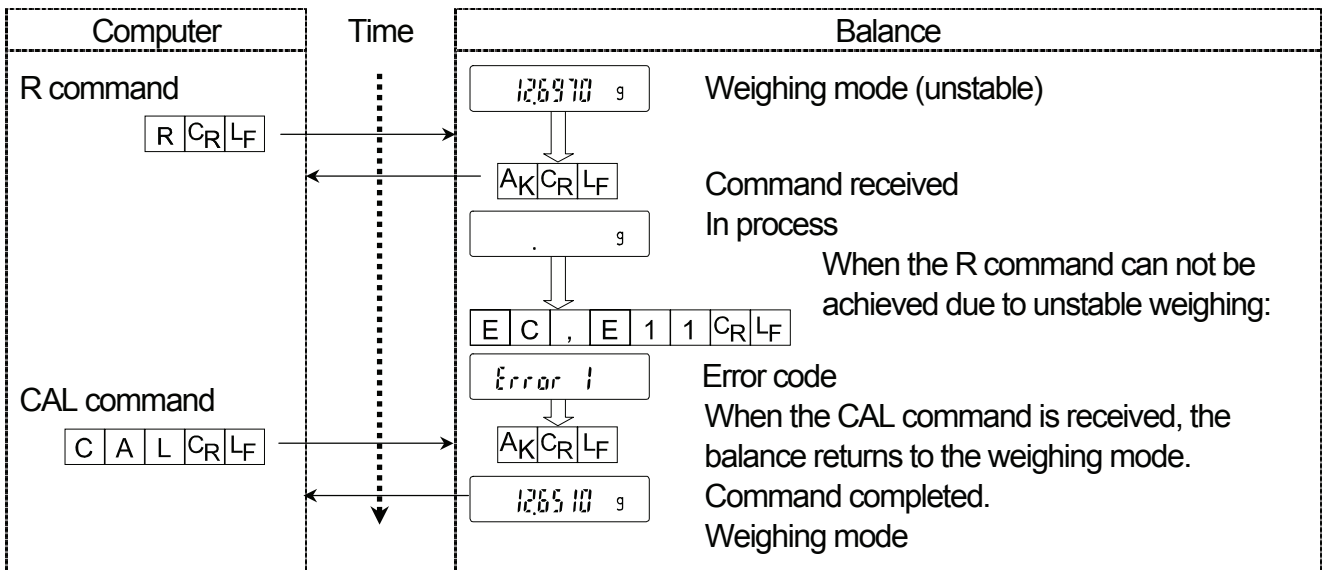

## Weighing with a tare

This example uses "Error 1" of "SIF" so that the <AK> (06h) code is output.

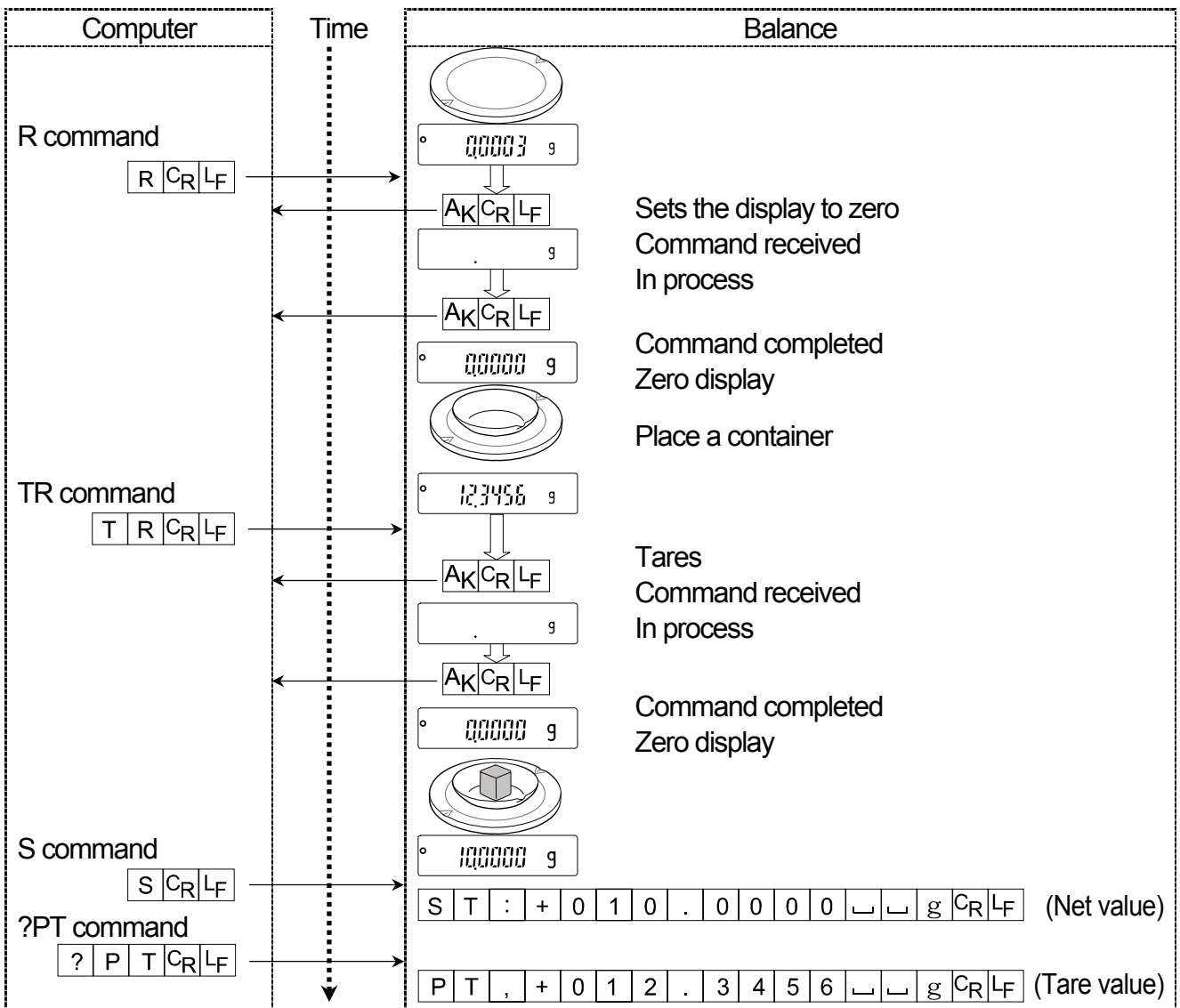

## Setting a negative target value and filling with a sample until the display becomes zero

This example uses "ErCd on" of "S iF" so that the <AK> (06h) code is output.

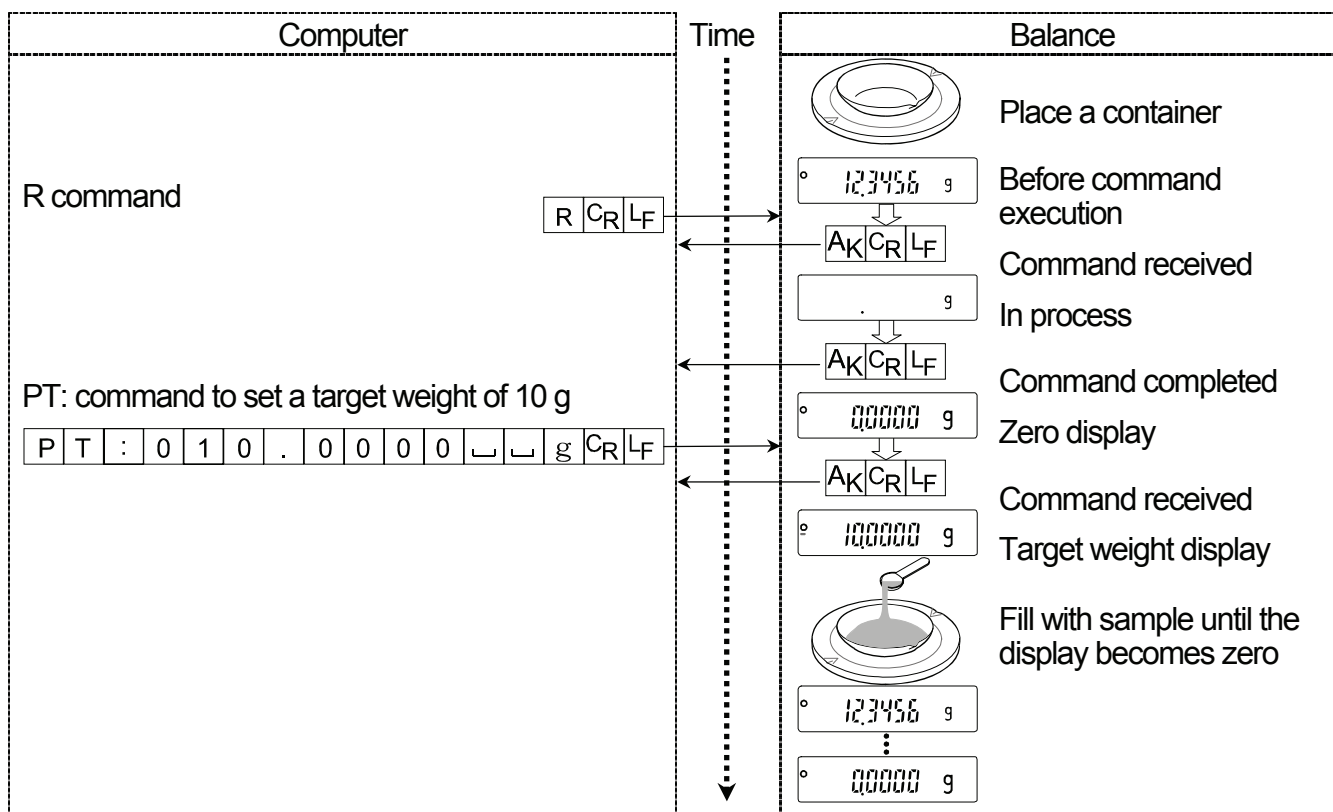









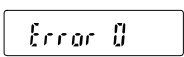
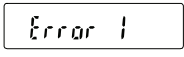

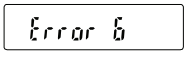
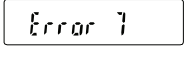
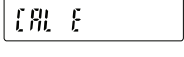

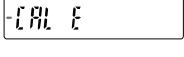
# 16. Maintenance

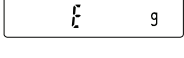
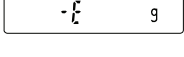
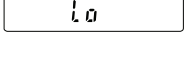
## 16.1. Treatment Of The Balance

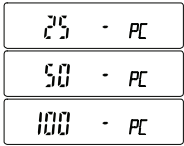
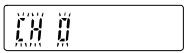
- Clean the balance with a lint free cloth that is moistened with warm water and a mild detergent.
- Do not use organic solvents to clean the balance.
- Do not disassemble the balance. Contact the local A&D dealer if the balance needs service or repair.
- Use the original packing material for transportation.
- Consider "3. Precautions" when operation the balance.

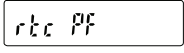
## 16.2. Error Codes

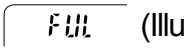
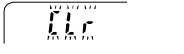
| Display   | Error code | Description   |
|---|------------|---|
|    | EC,E00     | <b>Internal error</b><br>If displaying this error continuously, contact your local A&D dealer to repair the balance.  |
|    | EC,E11     | <b>Stability error</b><br>The balance can not stabilize due to an environmental problem. Check around the pan. Prevent vibration, drafts, temperature changes, static electricity and magnetic fields, from influencing the balance. Press the  key to return to the weighing mode. |
|  | EC,E16     | <b>Internal mass error</b><br>Applying the internal mass does not yield a change in the mass value as specified. Confirm that there is nothing on the pan and perform the weighing operation from the beginning again.  |
|  | EC,E17     | <b>Internal mass error</b><br>The internal mass application mechanism does not function properly. Perform the weighing operation from the beginning again.  |
|  | EC,E20     | <b>Calibration weight error</b><br>The calibration weight is too heavy. Confirm the calibration mass value. Press the  key to return to the weighing mode.   |
|  | EC,E21     | <b>Calibration weight error</b><br>The calibration weight is too light. Confirm the calibration mass value. Press the  key to return to the weighing mode.   |
|  |            | <b>Overload error</b><br>A sample beyond the balance weighing capacity has been placed on the pan. Remove the sample from the pan.  |
|  |            | <b>Weighing pan Error</b><br>The mass value is too light.<br>Confirm that the weighing pan is properly installed and calibrate the balance.   |
|  |            | <b>Sample mass error</b><br>The balance can not store the sample for the counting mode or for the percent mode because it is too light. Use a larger sample.  |

| Display   | Error code | Description   |
|---|------------|---|
|                |            | <p><b>Unit mass error</b></p> <p>The sample unit mass for the counting mode is too light. Storing and using it for counting will cause a counting error.</p> <p>Add samples to reach the specified number and press the <b>PRINT</b> key. Pressing the <b>PRINT</b> key without adding samples will shift the balance to the counting mode. But, for accurate counting, be sure to add samples.</p> |
|                |            | <p><b>Automatic response adjustment zero error</b></p> <p>The automatic response adjustment can not be performed because there is something on the pan. Clear the pan. Press the <b>CAL</b> key to return to the weighing mode.</p>   |
| <br>(Check NG) |            | <p><b>Automatic response adjustment unstable error</b></p> <p>The automatic response adjustment can not be performed because the mass value is unstable.</p> <p>Check the ambient conditions such as breeze, vibration and magnetic fields, also check the weighing pan.</p> <p>Press the <b>CAL</b> key to return to the weighing mode.</p>  |
|                |            | <p><b>Clock battery error</b></p> <p>The clock backup battery has been depleted.</p> <p>Press any key and set the time and date. The clock and calendar function works normally as long as the AC adapter is connected to the balance. If this error appears frequently, contact the local A&amp;D dealer.</p>  |
|              |            | <p><b>Memory full</b></p> <p>The amount of weighing data in memory has reached the maximum capacity. Delete data in memory to store new data. For details, refer to "12. Data Memory".</p>  |
|              |            | <p><b>Memory full</b></p> <p>The amount of calibration or calibration test data in memory has reached the maximum capacity (50 sets).</p> <p>The data in memory will be deleted automatically to store new data. For details, refer to "12. Data Memory".</p>   |
|              |            | <p><b>Memory type error</b></p> <p>Type of memory set in the function table and type of data stored are different. For details, refer to "12. Data Memory".</p>   |
|              |            | <p><b>Memory data error</b></p> <p>A fatal error occurs in the stored data. To use the memory function, erase all the old data and release the error. For details, refer to "12.1. Notes on Using Data Memory".</p>   |
|   | EC,E00     | <p><b>Communications error</b></p> <p>A protocol error occurred in communications.</p> <p>Confirm the format, baud rate and parity.</p>   |
|   | EC,E01     | <p><b>Undefined command error</b></p> <p>An undefined command was received.</p> <p>Confirm the command.</p>   |

| Display          | Error code | Description  |
|------------------|------------|--|
|                  | EC,E02     | <p><b>Not ready</b><br/>A received command can not be processed.<br/>Example:</p> <ul style="list-style-type: none"> <li>□ The balance received a "Q" command, but not in the weighing mode.</li> <li>□ The balance received a "Q" command while processing a RE-ZERO command. Adjust the delay time to transmit a command.</li> </ul> |
|                  | EC,E03     | <p><b>Timeout error</b><br/>If the timeout parameter is set to "t-UP on", the balance did not receive the next character of a command within the time limit of one second. Confirm the communication.</p>  |
|                  | EC,E04     | <p><b>Excess characters error</b><br/>The balance received excessive characters in a command. Confirm the command.</p>   |
|                  | EC,E06     | <p><b>Format error</b><br/>A command includes incorrect data.<br/>Example:</p> <ul style="list-style-type: none"> <li>□ The data is numerically incorrect. Confirm the command.</li> </ul>   |
|                  | EC,E07     | <p><b>Parameter setting error</b><br/>The received data exceeds the range that the balance can accept. Confirm the parameter range of the command.</p>   |
| Other error code |            | If an error described above can not be released or other errors are displayed, contact the local A&D dealer.   |

## 16.3. Other Display



When this indicator blinks, automatic self calibration is required. The indicator blinks when the balance detects changes in ambient temperature. If the balance is not used for several minutes with this indicator blinking, the balance performs automatic self calibration. The blinking period depends on the operating environment.

Advise

The balance can be used while this indicator is blinking. We recommend that you perform automatic self calibration for precision weighing.



## 16.4. Checking The Balance Performance And Environment

The balance is a precision instrument. When the operating environment or the operating method is inadequate, correct weighing can not be performed. Place a sample on the pan and remove it, and repeat this several times. If the balance seems to have a problem with repeatability or to perform improperly, check as described below. If improper performance persists after checking, contact the local A&D dealer for repair.

### Checking that the operating environment or weighing method is proper

#### Operating environment

- Is the weighing table solid enough?
- Is the balance level?
- Is the operating environment free from vibration and drafts?
- Is there a strong electrical or magnetic noise source such as a motor near the balance?

#### Weighing method

- Does the weighing pan rim touch anything? Is the weighing pan assembly installed correctly?
- Is the **RE-ZERO** key pressed before placing a sample on the weighing pan?
- Is the sample placed in the center of the weighing pan?
- Is the fine range ring installed for weighing with a minimum display of 0.01 mg for the **BM-252**?
- Is the fine range ring and small fine range ring installed for weighing with a minimum display of 0.001 mg for the **BM-22** and **BM-22**?
- Has the balance been calibrated using the internal mass (one-touch calibration)?
- Has the balance been warmed up for one hour before weighing?

#### Sample and container

- Has the sample absorbed or lost moisture due to the ambient conditions such as temperature and humidity?
- Has the temperature of the container been allowed to equalize to the ambient temperature?
- Is the sample charged with static electricity?
- Is the sample of magnetic material such as iron? There are cautions about weighing magnetic materials.

### Checking that the balance performs properly

- Check the balance performance using an external weight. Be sure to place the weight in the center of the weighing pan.
- Check the balance repeatability, linearity and calibrated value using external weights with a known value.

## 16.5. Asking For Repair

If the balance needs service or repair, contact your local A&D dealer.

The balance is a precision instrument. Use much care when handling the balance and observe the following when transporting the balance.

- Use the original packing material for transportation.
- Remove the weighing pan, pan support, rings and dust plate from the main unit.

# 17. Specifications

|   | BM-20  | BM-22  | BM-252  | BM-500                                   | BM-300                          | BM-200                 |
|---|--|--|---|--|---------------------------------|------------------------|
| Weighing capacity                               | 22 g   | 22 g<br>5.1 g  | 250 g   | 520 g                                    | 320 g                           | 220 g                  |
| Maximum display                                 | 22.000084 g  | 22.00008 g<br>*1 5.100009 g                                | 250.00084 g   | 520.0084 g                               | 320.0084 g                      | 220.0084 g             |
| Minimum display                                 | 0.001 mg   | 0.01 mg<br>0.001 mg  | 0.01 mg   | 0.1 mg                                   |                                 |                        |
| Repeatability<br>(Standard deviation)           | *2 0.0025 mg   | 0.01 mg<br>*2 0.004 mg                                     | *3 0.03 mg  | 0.2 mg                                   |                                 | 0.1 mg                 |
| Linearity                                       | ±0.010 mg  | ±0.02 mg<br>±0.010 mg                                      | ±0.10 mg  | ±0.5 mg                                  | ±0.3 mg                         | ±0.2 mg                |
| Stabilization time<br>(Typical at <b>FAST</b> ) | Approx. 10 seconds   | Approx. 8 seconds  |   | Approx. 3.5 seconds                      |                                 |                        |
| Sensitivity drift                               | ±2 ppm/°C (10 °C to 30 °C, Automatic self calibration: OFF)  |  |   |  |                                 |                        |
| Operating environment                           | 5 °C to 40 °C, 85 %RH or less (No condensation)  |  |   |  |                                 |                        |
| Display refresh rate                            | 5 times/second or 10 times/second  |  |   |  |                                 |                        |
| Environmental sensors                           | Resolution: Temperature ±1.5 °C, Humidity ±10 %, Air pressure ±10 hPa<br>Applicable range: 5 °C to 40 °C   |  |   |  |                                 |                        |
| Counting mode                                   | Minimum unit mass  | 0.1 mg   |   |  |                                 |                        |
|   | Number of samples  | 10, 25, 50 or 100 pieces                                   |   |  |                                 |                        |
| Percent mode                                    | Minimum 100% reference mass  | 1 mg   | 10 mg   |  |                                 |                        |
|   | Minimum display  | 0.01 %, 0.1 %, 1 % (Depends on the reference mass stored.) |   |  |                                 |                        |
| Interface                                       | USB and RS-232C with Windows Communication Tools Software WinCT  |  |   |  |                                 |                        |
| External calibration weight                     | 20 g<br>10 g<br>5 g<br>2 g<br>1 g  | 20 g<br>10 g<br>5 g<br>2 g<br>1 g                          | 200 g<br>100 g<br>50 g<br>20 g<br>10 g              | 500 g<br>300 g<br>200 g<br>100 g<br>50 g | 300 g<br>200 g<br>100 g<br>50 g | 200 g<br>100 g<br>50 g |
| Size of loading area for weighing<br>mm         | Weighing pan: φ25,<br>Filter weighing: φ50, φ95<br>Test tube holder: φ12   |  | Weighing pan: φ90<br>Test tube holder: φ12 (Option) |  |                                 |                        |
| External dimensions                             | 259(W) x 466(D) x 326(H) mm  |  |   |  |                                 |                        |
| Power supply & AC adapter type                  | Power consumption: Approx. 30VA (supplied to the AC adapter )<br>Confirm that the adapter type is correct for the local voltage and power receptacle type. |  |   |  |                                 |                        |
| Mass  | Approx. 10 kg  |  |   |  |                                 |                        |

- The operating environment does not include excessive change of ambient temperature, humidity, vibration, drafts, magnetic fields and static electricity.
- The internal mass may change due to corrosion or other damage caused by the operating environment, or due to aging. Check the internal mass periodically and correct the internal mass value if necessary.

\*1 When placing the tare weight within the standard range, if using the smart range, the weighing sample can be weighed within the precision range.

\*2 The repeatability for 1 gram within the weighing capacity.

\*3 The repeatability for 100 gram within the weighing capacity.

# 17.1. External Dimensions

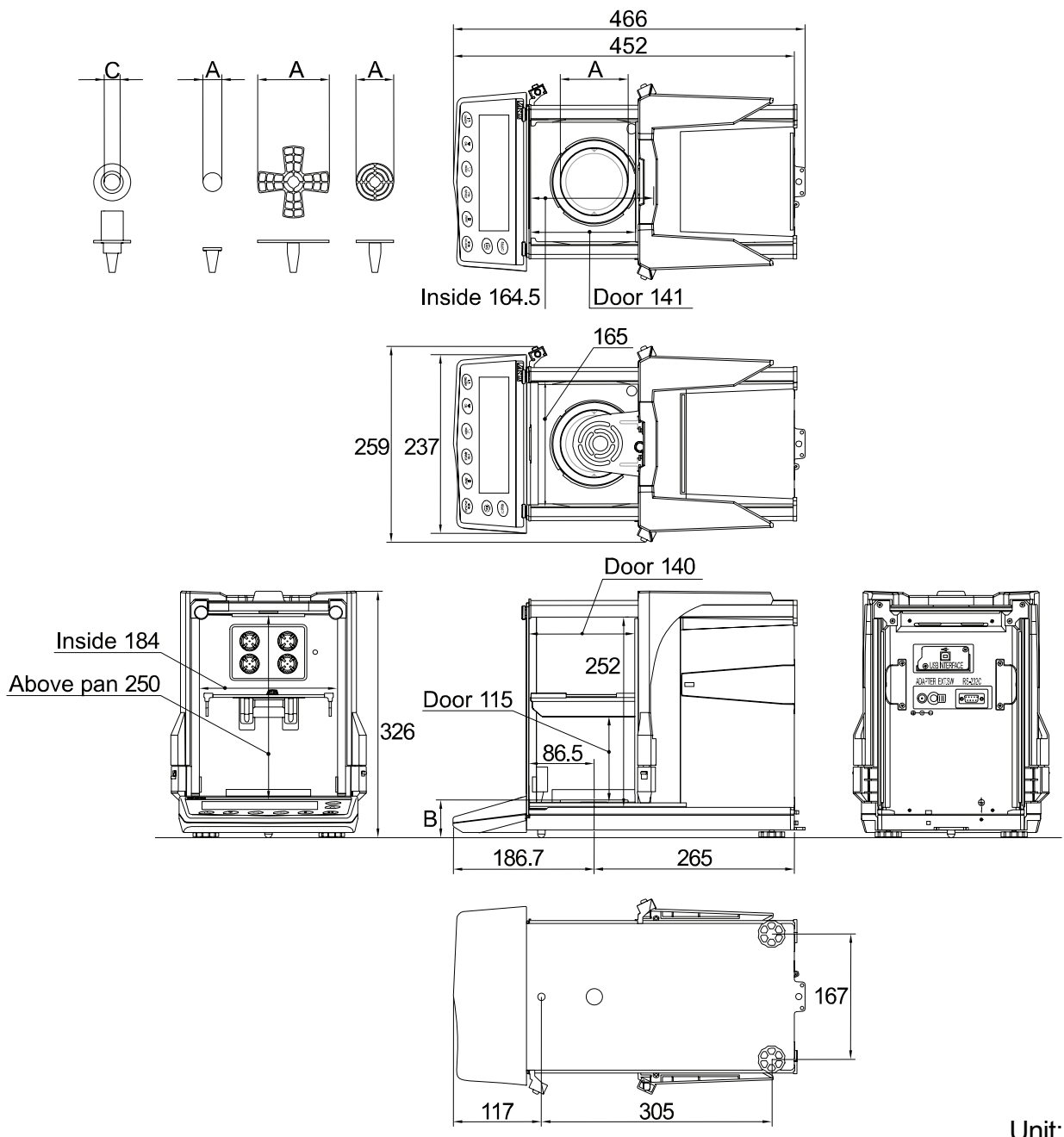

Unit: mm

|   | BM-20, BM-22   | BM-200, BM-300<br>BM-500, BM-252 |
|---|--|----------------------------------|
| <b>A:</b> Diameter of the weighing pan                | Weighing pan: $\phi 25$<br>Weighing pan for filter: $\phi 50, \phi 95$ | Weighing pan: $\phi 90$          |
| <b>B:</b> Height of the weighing pan                  | 54   | 50                               |
| <b>C:</b> The inside diameter of the test tube holder | $\phi 12$  | $\phi 12$ (Option)               |

## 17.2. Options And Peripheral Equipment

### Ethernet Interface BM-08

- The interface to connect the balance to a LAN.
- Accessory: The "WinCT-Plus" data communication software.
  - The software can acquire data from multiple balances connected to a LAN.
  - The software can control these balances with commands.
  - The software can acquire data transmitted from balances.
 

Example: When pressing the **PRINT** key of the balance, data is output and is acquired by the computer.
  - The stored data can be used with Microsoft EXCEL (if installed).

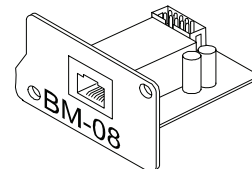

|    | BM-252   |    | BM-300    |   |          |    |           |   |
|----|----------|----|-----------|---|----------|----|-----------|---|
| 1  | 11:19:43 | ST | +018.2252 | g | 11:20:02 | ST | +019.2181 | g |
| 2  | 11:19:49 | ST | +018.2253 | g | 11:20:05 | ST | +019.2182 | g |
| 3  | 11:21:07 | ST | +018.2955 | g | 11:20:12 | ST | +019.2182 | g |
| 4  | 11:21:12 | ST | +018.2964 | g | 11:20:39 | ST | +019.2898 | g |
| 5  | 11:21:17 | ST | +018.2965 | g | 11:20:47 | ST | +019.2182 | g |
| 6  | 11:21:33 | ST | +018.6676 | g | 11:23:02 | ST | +019.2184 | g |
| 7  | 11:21:41 | ST | +018.2251 | g | 11:23:09 | ST | +019.2180 | g |
| 8  | 11:21:51 | ST | +018.2251 | g | 11:23:16 | ST | +019.2180 | g |
| 9  | 11:22:00 | ST | +018.2965 | g |          |    |           |   |
| 10 | 11:22:30 | ST | +018.2265 | g |          |    |           |   |
| 11 | 11:22:33 | ST | +018.2252 | g |          |    |           |   |
| 12 | 11:22:40 | ST | +018.2239 | g |          |    |           |   |

### Pipette Accuracy Tester BM-014

- This option can be used to inspect the volume dispensed from the pipette.
- Accessory evaporation trap is used to prevent the evaporation of the test liquid inside it.
- The WinCT-Pipette software converts the test liquid mass into a volumetric value.

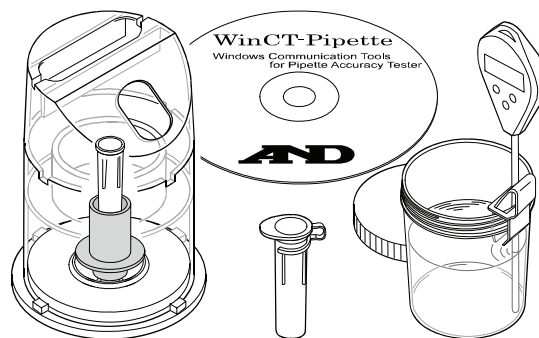

### Electrode Unit of the DC Static Eliminator AX-BM-NEEDLESET (4 pieces)

- Use these electrode units for replacement parts of the DC static eliminator built into the balance.
- Replace all four units with new ones at the same time.
- Refer to "6.5. Built-in DC Static Eliminator" for the replacement.

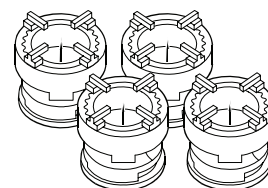

### Display Cover AX-BM-031 (5 pieces)

- This option is the same as the accessory display cover.

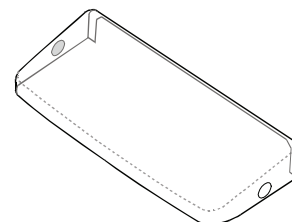

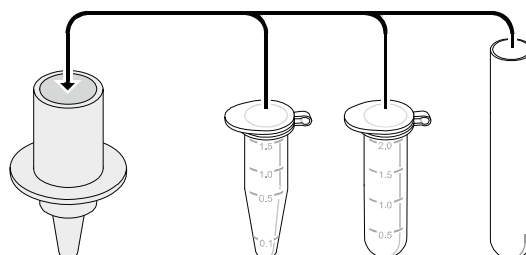

### Test Tube Holder AX-BM-032

- This option is the same as the accessory test tube holder.



## Aluminum Pans

- This option is the same as the accessory aluminum pans used for weighing of a very small amount of sample.

| Name and description              |     |         |            | Order code     | View  |
|-----------------------------------|-----|---------|------------|----------------|---|
| Round aluminum analytical pan (L) | φ15 | 0.8 ml  | 100 pieces | AX-ROUND-PAN-L |  |
| Round aluminum analytical pan (M) | φ12 | 0.3 ml  | 100 pieces | AX-ROUND-PAN-M |  |
| Round aluminum analytical pan (S) | φ8  | 0.05 ml | 100 pieces | AX-ROUND-PAN-S |  |

## AD-1653 Density Determination Kit

### Cautions

- The BM-20 and BM-22 can not use this kit.

$$\frac{\text{Weigh in air}}{\text{Weigh in water} - \text{Weigh in the air}} \times \text{water density} = \text{sample density}$$

Example  $\frac{10.0000 \text{ g}}{10.0000 \text{ g} - 9.5334 \text{ g}} \times 0.9970 \text{ g/cm}^3 = 21.4 \text{ g/cm}^3$

| Temperature | Water density             |
|-------------|---------------------------|
| 0°C         | 0.99984 g/cm <sup>3</sup> |
| 10°C        | 0.99970 g/cm <sup>3</sup> |
| 20°C        | 0.99820 g/cm <sup>3</sup> |
| 30°C        | 0.99565 g/cm <sup>3</sup> |

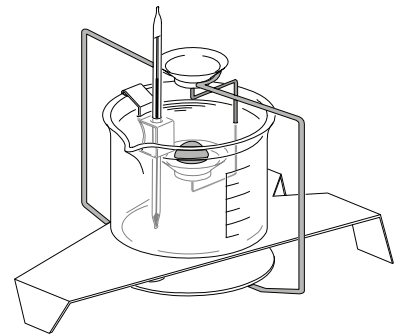

## AD-1683 DC Static Eliminator

- The eliminator is able to dissipate static electricity on a charged sample.
- The eliminator does not use a ventilator and can be used in precision powder weighing.

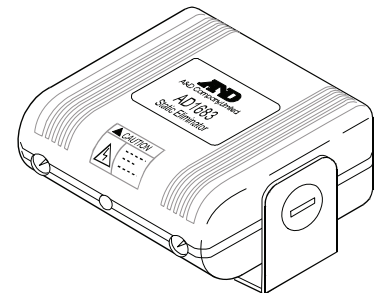

## AD-8121B Printer

- Compact dot-matrix printer
- Statistical function, clock and calendar function, interval print function, graphic print function, dump print mode
- 5 x 7 dots, 16 characters per line
- Print paper (AX-PP143, 45 (W) x 50 (L) mm , ø65 mm)
- AC adapter or alkaline battery

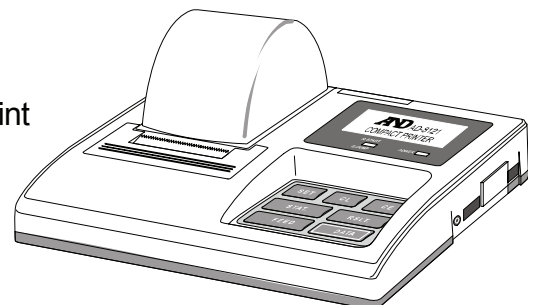

## AX-USB-9P-EX USB Converter

- Adds a COM port to a PC.
- Enables bi-directional communication between the PC and the balance when a USB driver is installed.
- Can use serial communication software such as WinCT on a PC without COM ports.
- An RS-232C cable is provided to connect the USB converter to the balance.

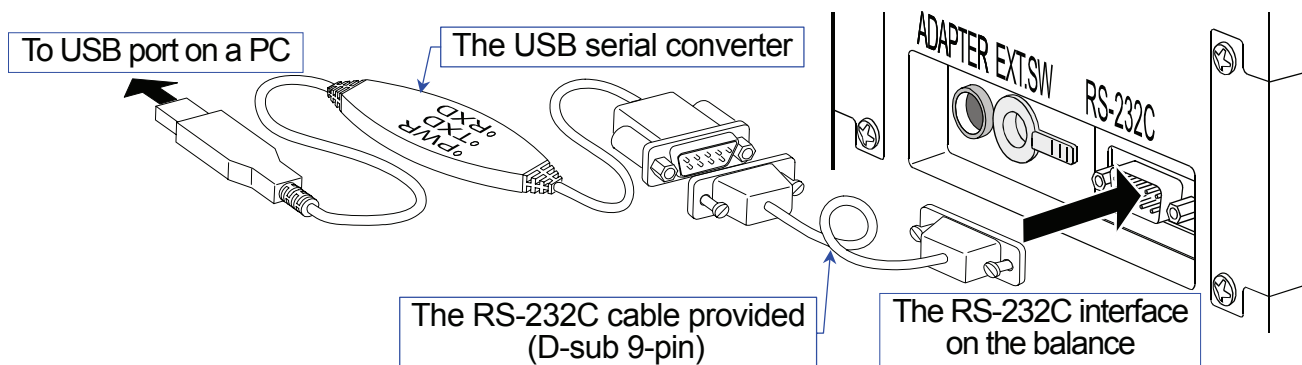

## AX-T-314A-S External key Plug

- This plug produces the same operations as pressing the **RE-ZERO** and **PRINT** keys. It enables remote control of the balance using an external switch.
- This operation must connect the GND line to the PRINT or RE-ZERO line for at least 100 milliseconds.

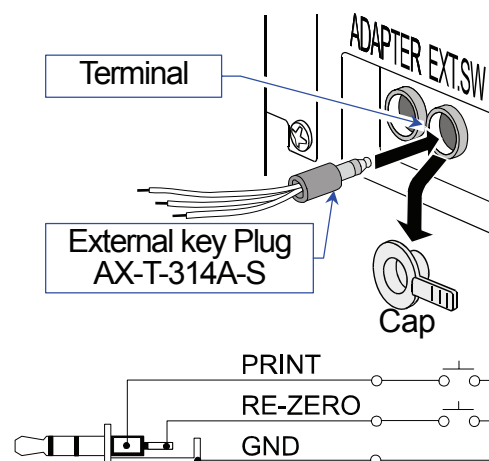

## AX-SW128 Foot switch

- The switch can be used to connect the external key plug and used to the **RE-ZERO** or **PRINT** keys.

**Note** When the foot switch is to be used, prepare the AX-SW128 and AX-T-314A-S beforehand.

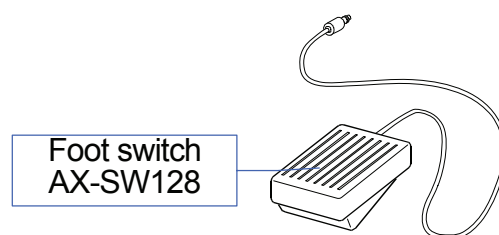

## Other Options

| Order code | Name and description  |
|------------|---|
| AD-1670    | <p><b>Anti-vibration table</b></p> <ul style="list-style-type: none"> <li>□ Approximately 24kg, Artificial stone (Terrazzo).</li> <li>□ Use this table when unstable weighing is caused by vibration coming from the floor.</li> <li>□ Use the AD-8922 remote controller to avoid a weighing error by a slight table tilt that key operation may make.</li> </ul> |
| AD-1682    | <p><b>Rechargeable Battery</b></p> <ul style="list-style-type: none"> <li>□ This option allows use of the balance in a place where AC power is not available.</li> </ul>  |
| AD-1684    | <p><b>Electrostatic field meter</b></p> <ul style="list-style-type: none"> <li>□ This option measures the amount of the static charge on the sample, tare or peripheral equipment and displays the result.</li> </ul> <p>If those are found to be charged, discharge them using the AD-1683 DC static eliminator.</p>   |
| AD-1688    | <p><b>Data logger</b></p> <ul style="list-style-type: none"> <li>□ When connected to the RS-232C interface of the balance, the AD-1688 can store the data in an environment where a personal computer can not be used.</li> </ul>   |
| AD-1689    | <p><b>Tweezers for calibration weight</b></p> <ul style="list-style-type: none"> <li>□ This option is the same as the tweezers provided as a standard accessory and is used when calibrating the balance using an external weight.</li> </ul>   |
| AD-8526    | <p><b>LAN Converter</b></p> <ul style="list-style-type: none"> <li>□ This option can be used to connect the RS-232C interface of the balance to the Ethernet (LAN) port of a computer. This allows management of the balance weighing data with a computer connected to a network.</li> </ul>   |
| AD-8920A   | <p><b>Remote Display</b></p> <ul style="list-style-type: none"> <li>□ This option can be connected to the balance using the RS-232C interface.</li> </ul>   |
| AD-8922A   | <p><b>Remote Controller</b></p> <ul style="list-style-type: none"> <li>□ This option can be connected to the balance using the RS-232C interface and can control the balance remotely.</li> <li>□ Various options such as comparator output or analog output are available.</li> </ul>  |
| AX-MX-36   | <p><b>Tweezers for filter weighing</b> <span style="float: right;">2 pieces</span></p>  |

# 18. Terms/Index

## 18.1. Terms

|                    |  |
|--------------------|--|
| Calibration        | Adjustment of the balance so that it can weigh accurately.   |
| Calibration weight | A mass used for calibration.   |
| Data number        | Numbers assigned sequentially when weighing data or unit weight is stored.   |
| Digit              | The minimum weighing value available. Used for the balance, one digit is the smallest mass that can be displayed.  |
| Environment        | Ambient conditions such as vibration, drafts, temperature, static electricity and magnetic fields which affect the weighing operation.   |
| External weight    | The weight that you have.  |
| GLP                | Good Laboratory Practice.  |
| GMP                | Good Manufacturing Practice.   |
| Internal mass      | Built-in calibration weight.   |
| ISO                | International Organization for Standardization   |
| Micro tube         | 2 ml and 1.5 ml micro tubes in the market can be weighed with the test tube holder that is an accessory of <b>BM-20</b> and <b>BM-22</b> .   |
| Repeatability      | Variation in measured values obtained when the same mass is placed and removed repetitively. Usually expressed as a standard deviation.<br>Example: "Standard deviation = 1 digit " means that may occur a weighing error within $\pm 1$ digit in the frequency of approx. 68% when weighing the same mass repeatedly.   |
| Re-zero            | To set the display to zero.  |
| Sensitivity drift  | An affect that a change in temperature causes to the weighing data. Expressed as a temperature coefficient.<br>Example: Temperature coefficient = 2 ppm/°C, If a load is 10 g and the temperature changes by 10°C, the value displayed changes by the following value.<br>$0.000\ 002\ \text{ppm}/^{\circ}\text{C} \times 10\ ^{\circ}\text{C} \times 10\ \text{g} = 0.0002\ \text{g}$ |
| Stabilization time | Time required after a sample being placed, until the stabilization indicator illuminates and the weighing data is displayed.   |
| Tare               | To cancel the mass value of a container which is not to be included in the weighing data. Normally, refers to an operation of placing a container and setting the display to zero.   |
| Target mass        | An external weight used for calibration test   |
| Zero point         | A weighing reference point. Usually refers to the value displayed when nothing is on the weighing pan.   |

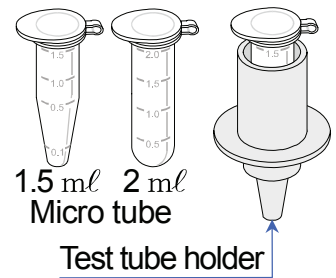



## 18.2. Index

- Left, Upper, Lighting, Stabilization indicator ..... 13, 20, 39
- ◀ Left, Upper, Lighting, Process indicator ..... 13, 31
- ☀ Left, Upper, Blinking, Density mode ..... 13
- ◀ Left, Lower, Lighting, Standby indicator ..... 13
- ☀ Left, Lower, Blinking, Prior notice of calibration .. 13, 32, 78
- door Right, Upper, Lighting, Shut side glass door..... 20
- in Right, Upper, Lighting, Interval mode, Standby ..... 13, 59
- in Right, Upper, Blinking, Interval mode, Action..... 13, 59
- RESPONSE [FAST] [MID.] [SLOW] Response indicator ..... 13
- ION ION mark..... 25
- └ Space mark..... 49, 50, 53 - 57
- ION ON-OFF ON:OFF key ..... 13
- CAL CAL key..... 13, 39
- ION ION key ..... 13, 25
- MODE MODE key ..... 13, 14, 18
- PRINT PRINT key..... 13, 39
- RANGE RANGE key ..... 13, 39
- RE-ZERO RE-ZERO key ..... 13, 39
- SELECT SELECT key ..... 13
- 8922 AD-8922A control ..... 26, 43
  
- AC adapter ..... 6, 7, 9, 10, 12
- ACAI ..... 23
- AD-1653 Density determination kit ..... 83
- AD-1670 Anti-vibration table ..... 85
- AD-1682 Rechargeable battery ..... 85
- AD-1683 DC static eliminator..... 83
- AD-1684 Electrostatic field meter ..... 85
- AD-1688 Weighing data logger..... 4, 6, 85
- AD-1689 Tweezers for calibration weight..... 6, 85
- AD-8121B Printer..... 53 - 57, 68, 83
- AD-8526 LAN converter ..... 85
- AD-8920A Remote display ..... 85
- AD-8922A Remote controller ..... 43, 85
- Air buoyancy..... 11
- Air pressure ..... 13, 27
- AK code ..... 72 - 75
- Anti theft device ..... 7
- Anti-vibration table AD-1670 ..... 10, 85
- AP-b Auto print difference..... 41, 45, 68
- AP-P Auto print polarity ..... 41, 45, 68
- AR-d Zero after output ..... 42, 45
- AT-F Auto feed..... 42, 68
- Auto display-ON ..... 41, 44
- Auto feed ..... 42
- Auto print ..... 41, 45
- AX-BM-031 Display cover ..... 82
- AX-BM-032 Test tube holder ..... 82
- AX-BM-NEEDLESET Electrode units..... 82
- AX-MX-36 Tweezers ..... 6, 85
- AX-ROUND-PAN-S Aluminum pan,φ8, 0.05ml ... 83
- AX-ROUND-PAN-M Aluminum pan,φ12, 0.3ml ... 83
- AX-ROUND-PAN-L Aluminum pan,φ15, 0.8ml ... 83
- AX-SW128 Foot switch ..... 26, 84
- AX-T-314A-S External key plug..... 26, 84
- AX-USB-9P USB Converter ..... 84
- bRSFnc Environment & Display ..... 39, 41
- Baud rate ..... 42, 67
- bEEP beep..... 41
- Best condition ..... 10
- BM-014 Pipette accuracy tester ..... 82
- BM-08 Ethernet interface..... 4, 82
- Bottle holder..... 6
- bPS Baud rate..... 42, 68
- Breeze break ring ..... 6, 8
- bEP Data bit, parity bit..... 42, 68
- Bubble spirit level..... 7, 9
- └[RL Automatic self calibration ..... 32
- [RL E Calibration error. Too heavy ..... 76
- [RL E Calibration error. Too light ..... 76
- [RL in One-touch calibration..... 32, 53
- Calibration ..... 31, 86
  - Automatic self calibration..... 31, 32, 37, 78
  - Calibration using an external weight..... 37
  - Correcting the internal mass value ..... 31, 36, 37, 43
  - One-touch calibration ..... 31, 32, 37
- Calibration report ..... 31, 32, 34, 53, 55, 58
- Calibration test
  - Calibration test using an external weight ..... 31, 35
  - Calibration test using the internal mass..... 31, 33, 34
- Calibration test report ..... 33 - 56, 58
  - [RL out Calibration using an external weight ... 34, 55
  - [E out Calibration test ..... 35, 56
  - [E in Calibration test ..... 33, 54
- Celsius & Centigrade..... 27
- [H 0 CHECK 0..... 29, 76
- [H nG CHECK NG ..... 29, 76
- Characters for display..... 52
- [L Add Clock..... 41, 48, 51
- [LEAr Delete memory data..... 61, 62
- Clock function ..... 27, 80, 83
  - [Lr Initializing the balance ..... 38, 58, 62
  - [Lr Memory error..... 76
  - [Lr Go Initialization, Perform..... 38, 58, 61, 62
  - [Lr no Initialization, Cancel ..... 38, 58, 61, 62
- Command ..... 71, 73 - 75

|  |                       |   |                          |
|--|-----------------------|---|--------------------------|
| Communication function .....                   | 80                    | External key jack.....                      | 7, 84                    |
| <i>Cond</i> Condition .....                    | 29, 30, 41, 43        | External key Plug <b>AX-T-314A-S</b> .....  | 26, 84                   |
| Container .....                                | 6, 20, 22, 24         | FAST .....                                  | 29, 30                   |
| Counting mode.....                             | 22                    | FCC .....                                   | 5                        |
| CR <b>Carriage return</b> .....                | 49, 53 - 57           | Filter .....                                | 6, 8                     |
| <i>CrLF</i> Terminator .....                   | 42, 68, 71            | Fine range ring.....                        | 6, 8, 11                 |
| <i>CS in</i> Internal mass correction .....    | 36, 43                | Foot switch <b>AX-SW128</b> .....           | 26, 84                   |
| <i>-d-</i> Weighing data .....                 | 58, 61                | <i>FUL</i> Memory full.....                 | 59, 62, 76               |
| <i>d 10000</i> Initial density .....           | 65                    | Glass door handle .....                     | 7                        |
| <i>dRtR</i> Data memory .....                  | 41, 58 - 60, 62       | <i>GLP</i> GLP output .....                 | 53 - 57                  |
| Data bits .....                                | 42                    | GLP .....                                   | 32 - 35, 42, 52 - 57, 86 |
| Data bits & parity bits.....                   | 67                    | GMP .....                                   | 86                       |
| Data format .....                              | 42, 46, 49, 50        | Grounding .....                             | 11                       |
| Data memory.....                               | 41, 58, 80            | Grounding terminal .....                    | 7, 11                    |
| Data memory function.....                      | 13, 58                | <i>HIS</i> Calibration report.....          | 58, 62                   |
| Data number.....                               | 13, 42, 47, 59, 86    | Humidity .....                              | 13, 27                   |
| Data output .....                              | 42                    | <i>id</i> ID number setting.....            | 43, 52                   |
| Data output mode.....                          | 41, 45                | ID number .....                             | 42, 43, 47, 52           |
| Data output pause.....                         | 42                    | Influence of magnetic fields.....           | 10, 11                   |
| Date .....                                     | 13, 42, 48, 51        | Influence of static electricity.....        | 11                       |
| <i>d-dt</i> Door Sensor.....                   | 43                    | <i>inFa</i> GLP output .....                | 42, 53 - 57, 62          |
| Decimal point.....                             | 41, 44, 47            | Inhibition .....                            | 37                       |
| Density meter .....                            | 43, 83                | Initializing .....                          | 37, 38                   |
| Density .....                                  | 4, 64 - 66, 83        | <i>int</i> Interval time .....              | 41                       |
| Density mode <b>IS</b> .....                   | 13, 64                | Interval mode <b>in</b> .....               | 4, 13, 41, 42, 45, 59    |
| Digit .....                                    | 86                    | Interval time .....                         | 42                       |
| Dimensions .....                               | 80                    | <i>ion</i> Neutralizing time .....          | 43                       |
| Discharge electrode .....                      | 25, 82                | Ion .....                                   | 25                       |
| Display cover.....                             | 6, 7, 82              | <i>ionFnc</i> neutralization function ..... | 26, 43                   |
| Display hold function .....                    | 41, 44                | Joint handle .....                          | 7                        |
| Display refresh rate .....                     | 41, 44                | Key   |                          |
| <i>d-no</i> Data number .....                  | 42, 60, 68            | <b>CAL Key</b> .....                        | 13, 39                   |
| <i>door</i> Door sensor function .....         | 43                    | <b>ION Key</b> .....                        | 13, 25                   |
| Door state function .....                      | 43                    | <b>MODE Key</b> .....                       | 13, 14, 18, 20, 39       |
| <i>dout</i> Data output .....                  | 41, 42, 45, 68        | <b>ON:OFF Key</b> .....                     | 13                       |
| <i>dS Fnc</i> Density function .....           | 43, 64                | <b>PRINT Key</b> .....                      | 13, 39                   |
| <i>d-t</i> Weighing data with calendar .....   | 58, 61                | <b>RANGE Key</b> .....                      | 13, 39                   |
| Dust plate .....                               | 6, 8                  | <b>RE-ZERO Key</b> .....                    | 13, 20, 39               |
| <i>E</i> Weighing error. Too heavy.....        | 76                    | <b>SELECT Key</b> .....                     | 13                       |
| <i>-E</i> Weighing error. Too light.....       | 76                    | Key Operation.....                          | 11, 13, 39               |
| Electrode unit of static eliminator .....      | 7, 25                 | LAN converter <b>AD-8526</b> .....          | 85                       |
| Electrostatic field meter <b>AD-1684</b> ..... | 85                    | <i>Ldin</i> Liquid density input .....      | 43, 64, 65               |
| Environment .....                              | 3, 10, 11, 13, 27, 79 | Leveling foot.....                          | 7, 9                     |
| Environmental sensor .....                     | 13, 27                | LF <b>Line feed</b> .....                   | 49, 53 - 57              |
| <i>ErEd</i> AK, Error code .....               | 43, 72 - 75           | Linearity .....                             | 80                       |
| <i>Err</i> Memory data error .....             | 76                    | <i>Lo</i> Sample mass error.....            | 22, 76                   |
| Error code .....                               | 43, 74, 76            | Magnetic substance.....                     | 4, 11, 63                |
| <i>E-S</i> External control Input.....         | 26, 43                | Mass of product .....                       | 80                       |
| Ethernet .....                                 | 4, 82                 | Maximum display.....                        | 80                       |
| Evaporation trap.....                          | 44, 82                | Micro tube .....                            | 86                       |
|  |                       | MID. ....                                   | 29, 30                   |
|  |                       | Minimum display.....                        | 80                       |

|                                  |                                      |                              |                                  |                     |
|----------------------------------|--------------------------------------|------------------------------|----------------------------------|---------------------|
| Neutralization.....              | 25, 43                               | <i>StArt</i>                 | Title block of output .....      | 57                  |
| Operating environment .....      | 80                                   | Static electricity .....     | 4, 25                            |                     |
| <i>out</i>                       | Report output .....                  | Static eliminator.....       | 4, 7, 13, 25, 43, 82             |                     |
| <i>out Go</i>                    | Report output, Start.....            | Static eliminator            | AD-1683 .....                    | 83                  |
| <i>out no</i>                    | Report output, cancel .....          | <i>St-b</i>                  | Stability detection .....        | 41, 43              |
| Pan support.....                 | 6, 8                                 | <i>St-d</i>                  | Time & Date output .....         | 42, 51, 58 - 60, 68 |
| Parity .....                     | 42, 67                               | Stop bit .....               | 67                               |                     |
| Percent mode.....                | 24                                   | <i>St-P</i>                  | Temperature output.....          | 42                  |
| Permission .....                 | 37                                   | Stream mode .....            | 41, 45                           |                     |
| Pipette .....                    | 44, 82                               | <i>t 25</i>                  | Initial temperature .....        | 65                  |
| <i>PLoc</i>                      | Display hold function.....           | Tare .....                   | 20, 74, 86                       |                     |
| <i>Pnt</i>                       | Decimal point .....                  | Tare weight .....            | 20                               |                     |
| <i>P-on</i>                      | Resume function.....                 | Temperature.....             | 4, 11, 13, 27, 48, 66, 80        |                     |
| Power consumption .....          | 80                                   | Temperature output .....     | 42                               |                     |
| Power source .....               | 10, 12, 80                           | <TERM>                       | Terminator .....                 | 53 -, 57            |
| Prior notice of calibration..... | 13, 32, 78                           | Terminator .....             | 42, 49, 53 - 57, 71              |                     |
| Processing indicator             | Left, Upper, Lighting ◀.....         | Test tube holder .....       | 8, 82, 86                        |                     |
| <i>Prt</i>                       | Data output mode .....               | Time .....                   | 13, 42, 48, 51                   |                     |
| <i>PS</i>                        | Function selection mode .....        | Timeout                      | <i>t-UP</i> .....                | 43                  |
| <i>PUSE</i>                      | Data output pause .....              | <i>trc</i>                   | Zero tracking .....              | 41, 44              |
| <i>rECALL</i>                    | Display format for memory data ..... | <i>t-UP</i>                  | Timeout.....                     | 43                  |
| <i>rEcEnd</i>                    | End block of output.....             | Tweezers .....               | 6, 11, 85                        |                     |
| Rechargeable Battery             | AD-1682 .....                        | <i>tYPE</i>                  | Data format.....                 | 42, 46, 68          |
| Relative Humidity .....          | 10, 11, 80                           | Underhook .....              | 63                               |                     |
| Remote Controller                | AD-8922A.....                        | Unit .....                   | 13 - 15, 17, 18, 21, 43, 50, 80  |                     |
| Remote Display                   | AD-8920A.....                        | <b>g</b>                     | Gram.....                        | 14, 15, 18, 50      |
| <i>rEP tEst</i>                  | Repeatability test .....             | <b>mg</b>                    | Milligram .....                  | 14, 15, 18, 50      |
| Repeatability.....               | 28, 80, 86                           | <b>PC</b>                    | Counting mode.....               | 14, 15, 18, 22, 50  |
| RESPONSE .....                   | 3, 4, 13, 29, 30, 41, 43             | <b>%</b>                     | Percent mode.....                | 14, 15, 18, 24, 50  |
| Round aluminum pan.....          | 6, 83                                | <b>OZ</b>                    | Ounce (Avoir).....               | 14, 15, 18, 50      |
| RS-232C .....                    | 4, 7, 67, 69                         | <b>OZt</b>                   | Troy Ounce.....                  | 14, 15, 18, 50      |
| RsCom                            | Command mode for WinCT .....         | <b>ct</b>                    | Metric carat.....                | 14, 15, 18, 50      |
| RsKey                            | Data output mode for WinCT .....     | <b>mom</b>                   | Momme .....                      | 14, 15, 18, 50      |
| <i>rtc PF</i>                    | Clock battery error .....            | <i>drwt</i>                  | Pennyweight.....                 | 14, 15, 18, 50      |
| Sensitivity drift.....           | 80                                   | <b>GN</b>                    | Grain (UK) .....                 | 14, 15, 18, 50      |
| Separation plate .....           | 6 - 8, 10, 25                        | <b>tL</b>                    | Tael (preset in the factory) ... | 14, 15, 18, 50      |
| Serial interface.....            | 42                                   | <b>t</b>                     | Tola (India).....                | 14, 15, 18, 50      |
| <i>St-id</i>                     | ID number output.....                | <b>m</b>                     | Messghal .....                   | 14, 15, 18, 50      |
| <i>StIF</i>                      | Serial interface .....               | <b>DS</b>                    | Density mode .....               | 14, 50, 66          |
| SLOW .....                       | 29, 30                               | <b>QC</b>                    | Centigrade.....                  | 14, 27              |
| Smart range.....                 | 4, 15, 21                            | <i>Unit</i>                  | Unit mode .....                  | 17, 43, 64          |
| <i>SPd</i>                       | Display refresh rate.....            | USB .....                    | 4, 7, 70                         |                     |
| Specific gravity.....            | 4, 64, 66, 83                        | USB converter                | AX-USB-9P .....                  | 84                  |
| Specific gravity meter           | AD-1653 .....                        | Water evaporation .....      | 44                               |                     |
| Stability .....                  | 3, 29, 30                            | Water temperature.....       | 65                               |                     |
| Stability band width.....        | 41, 43                               | Weighing capacity.....       | 80                               |                     |
| Stabilization indicator          | ○ .....                              | Weighing data logger         | AD-1688 .....                    | 4, 6, 85            |
| Stabilization time.....          | 80, 86                               | Weighing mode.....           | 14, 17, 18                       |                     |
| Standard deviation.....          | 28                                   | Weighing operation.....      | 11                               |                     |
| Standby indicator                | Left, Lower, Lighting ◀.....         | Weighing pan.....            | 6                                |                     |
|                                  |                                      | Weighing pan for filter..... | 6, 8                             |                     |
|                                  |                                      | Weighing response.....       | 29                               |                     |

|                                 |                         |  |        |
|---------------------------------|-------------------------|--|--------|
| Weight                          |                         |  |        |
| Adjustable range .....          | 31                      | WinCT-Pipette Software to inspect pipette..... | 82     |
| Calibration mass .....          | 12, 31, 34, 80, 86      | WinCT-Plus Software to connect to LAN .....    | 82     |
| Correction of mass value .....  | 43                      | Windows communication software WinCT .....     | 6, 69  |
| External weight.....            | 34, 35, 86              | <i>Ym d</i> Year, month, day .....             | 51     |
| Internal mass.....              | 28, 31 - 33, 43, 80, 86 | Zero   |        |
| Target mass value .....         | 35, 86                  | Automatic re-zero .....                        | 42     |
| Weight or Mass .....            | 31, 34, 35              | Re-zero .....                                  | 13, 86 |
| Weighing pan.....               | 8                       | Zero point.....                                | 86     |
| WinCT Communication Tools ..... | 4, 6, 69                | Zero tracking.....                             | 41, 44 |









**A&D Company, Limited**

3-23-14 Higashi-Ikebukuro, Toshima-ku, Tokyo 170-0013 JAPAN  
Telephone: [81] (3) 5391-6132 Fax: [81] (3) 5391-6148

**A&D ENGINEERING, INC.**

1756 Automation Parkway, San Jose, California 95131 U.S.A.  
Telephone: [1] (408) 263-5333 Fax: [1] (408)263-0119

**A&D INSTRUMENTS LIMITED <UK Office>**

Unit 24/26 Blacklands Way, Abingdon Business Park, Abingdon, Oxfordshire OX14 1DY United Kingdom  
Telephone: [44] (1235) 550420 Fax: [44] (1235) 550485

**A&D INSTRUMENTS LIMITED <German Sales Office>**

Große Straße 13 b 22926 Ahrensburg Deutschland  
Telefon: [49] (0) 4102 459230 Telefax: [49] (0) 4102 459231

**A&D Australasia Pty Ltd.**

32 Dew Street, Thebarton, South Australia 5031 AUSTRALIA  
Telephone: [61] (8) 8301-8100 Fax: [61] (8) 8352-7409

**A&D KOREA Limited**

한국에이.엔.디(주)  
대한민국 서울시 영등포구 여의도동 36-2 맨하탄 빌딩 8층  
( 8th Floor, Manhattan Bldg. 36-2 Yoido-dong, Youngdeungpo-ku, Seoul, KOREA )  
전화: [82] (2) 780-4101 팩스: [82] (2) 782-4280

**A&D RUS CO., LTD.**

Компания Эй энд Ди Рус  
121357, Российская Федерация, г.Москва, ул. Верейская, дом 17  
( Bldg. 17, Vereyskaya st., Moscow, 121357 RUSSIAN FEDERATION )  
тел.: [7] (495) 937-33-44 факс: [7] (495) 937-55-66

**A&D Instruments India Private Limited**

ऐ&डी इन्स्ट्र्यूमेन्ट्स इण्डिया प्रा० लिमिटेड  
509, उद्योग विहार , फेस -5, गुडगांव - 122016, हरियाणा , भारत  
( 509, Udyog Vihar, Phase-V, Gurgaon - 122 016, Haryana, India )  
फोन : 91-124-4715555 फैक्स : 91-124-4715599